

sigmaspectrum
operator's manual

Revision Date: 10/8/2009
SIGMA P/N 41018 Rev: AL

SIGMA International
711 Park Avenue
Medina, New York 14103
v 800 356 3454
f 585 798 3909
www.sigmapumps.com

CONTENTS

REMOVE FROM THE SHIPPING BOX	5
KEY OPERATING TIPS.....	6
BACKGROUND INFORMATION.....	7
Intended Device Use	7
System Components	8
Cautions and Warnings	8
SYMBOLS.....	9
ILLUSTRATIONS.....	10
Front View – Door Open.....	10
Front View – Pump Running with Standard Battery	11
Front View – Pump Running with Wireless Battery Module	12
Back View- With Standard Battery	13
Back View- With 802.11b Wireless Battery Module (P/N 35083).....	14
Back View- With 802.11b/g Wireless Battery Module (P/N 35162).....	15
SETUP AND OPERATION	16
Keys.....	16
Pre-Pump Programming.....	17
AC Power Adaptor	17
Set Loading (Unloading).....	18
Drug Error Prevention Programming.....	18
SW V5.02.03 and earlier versions.....	20
SW V 6.01 and later	20
Dose Rate Limits	20
Basic Programming	20
Secondary Infusion.....	21
Loading Dose Programming (SW V6.01 and later)	23
Manual /Multi-Step: (Ramp soft key- SW 5.02.03 and earlier), (Multi-Step soft key- SW 6.02 and later) Programming Mode	24
Cyclic TPN Mode – Software Version 6.02 and Later.....	25
Titration – Software version 5.02.03 and earlier.....	26
Patency Checks.....	26
Keypad Lock Operation.....	26
Auto keypad lock off	26
Auto keypad lock on	26
Pump Standby (Hold Mode)	27
Delayed Start.....	27
ALARMS	28
Air-in-Line	28
Audio.....	28
Depleted Battery.....	28
Door Not Fully Closed / Set Outside Channel	28
Door Open	28
Downstream Occlusion.....	28
Downstream Pressure Limit – Reset Setting.....	28
Infusion Complete.....	28
Inactive Alarm.....	28
In Stop – Slide Clamp Closed.....	28
Low Battery.....	28
Very Low Battery	29
Battery Missing	29
Shut Door.....	29
Slide Clamp Closed	29
System Error.....	29
Upstream Occlusion	29

TIPS	30
Prevent Nuisance Alarms.....	30
Managing Bolus before Occlusion (Downstream) Release.....	30
WARNINGS AND CAUTIONS	31
CLEANING AND STORAGE	35
Storing.....	35
Battery Disposal.....	36
Battery Charging.....	36
Battery Removal and Replacement.....	36
SERVICING	37
To Return Pumps to SIGMA.....	37
Required Maintenance and Frequency.....	37
ACCESSORIES	38
BATTERY COMPATIBILITY	40
SIGMA IV SETS	41
COMPATIBLE IV SETS	42
Compatible Hospira IV Sets – WARNINGS.....	43
Compatible Baxter IV Sets – WARNINGS.....	45
APPENDIX A - SPECIFICATIONS	49
Master Drug Library (MDL)	49
Drug Library Transfer.....	49
Infusion Modes.....	49
Standard Gravity IV Sets.....	49
Size and Weight.....	49
Battery.....	49
Pump Characteristics and Flow Rate Accuracy.....	50
Wireless Network Interface.....	50
Transmit power: 12 dBm typicalWireless Security.....	50
Environmental Limits.....	50
Display.....	50
Alarms and Alerts.....	50
Timekeeping.....	51
Logging Memory.....	51
AC Power.....	51
External Interfaces.....	51
Standards.....	51
FLOW RATE ACCURACY	53
Effect of Fluid Container Height ^{1,2}	53
Effect of Back Pressure ¹	53
Flow Profile.....	53
BOLUS ACCURACY	59
DOWNSTREAM OCCLUSION	59
Time to Occlusion.....	59
Bolus Volume.....	59
ELECTROMAGNETIC COMPATIBILITY	60
Emissions.....	60
Immunity – ESD, transient/burst, voltage disparity, magnetic.....	61
Immunity – Conducted and Radiated.....	62
Immunity – Separation Distances.....	63
Appendix B - Low / Very Low Battery Tutorial	65
Appendix C	68

Appendix C - Power Icons 69
Appendix C - Wireless icons 70
Appendix C - General Icons..... 72

REMOVE FROM THE SHIPPING BOX

The SIGMA Spectrum has been packaged to provide protection during transportation and storage. Remove the Spectrum from the protective anti-static bag and remove the protecting foam end caps. Discard the desiccant package.

The battery tab has been provided to isolate the battery voltage from the pump during transport and distribution. **Remove the battery insulating tab** prior to charging the pump's battery or operating the pump. This is accomplished by pulling the tab straight out from the Battery Pack mounting cavity.



Pull the battery tab straight out from the Battery Pack cavity.

- > It is suggested that all packaging materials be saved for reuse. This is advised in the event product repair or warranty replacement is necessary.
- > It is strongly recommended that the pump's battery be fully charged before depending on the battery as a source of pump power.

KEY OPERATING TIPS

1. FOLLOW ALL PROMPTS.
2. LOAD SETS PROPERLY.
To open the pump door, insert the gravity IV set's slide clamp fully into the keyhole. Load tubing tautly, from top to bottom in loading points 1, 2, 3 and 4, following the red/green prompts.
Push the door closed in the two door hook areas.
Open the slide clamp by pulling it straight up, while holding the tubing around it down.
3. USE THE DRUG ERROR PREVENTION SYSTEM.
DEP mode protects against human errors that could cause Adverse Drug Events.
BASIC mode can not detect human errors.
4. DO NOT DROP THE POWER SUPPLY.
The power supply is an electronic device. It is not simply a plug, and it will break if repeatedly dropped.
5. FOLLOW SECONDARY PROCEDURES
Use drop hooks to drop primary containers below secondary containers.
With secondary rates above 300 mL/hr, look for and clamp off primary line siphoning.

BACKGROUND INFORMATION

Intended Device Use

The Spectrum, Spectrum with Master Drug Library is intended to be used for the controlled administration of intravenous fluids. These fluids may include pharmaceutical drugs, blood, blood products, antibiotics, nutritional fluids and mixtures of required patient therapy. The intended routes of administration consist of the following clinically acceptable routes: intravenous, arterial, subcutaneous, intrathecal, epidural or irrigation of fluid space. The Spectrum is intended to be used in conjunction with legally marked intravenous administration sets and medications provided by the user.

The Spectrum and Spectrum with Master Drug Library is suitable for many user facility applications such as but not limited to hospitals, outpatient care areas, homecare and ambulatory care services.

The Spectrum and Spectrum with Master Drug Library is intended to reduce operator interaction through automated programming thereby helping to reduce errors associated with complex device programming. Parameter programming requires trained healthcare professional confirmation of limits and drug therapy to physician's directive.

System Components

SIGMA Spectrum Pump:



Fig 1

Standard gravity IV sets:

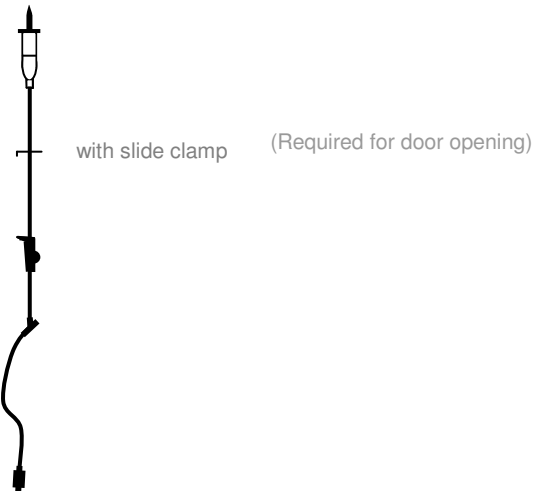

1 Master Drug Library (MDL)

The MDL is a software tool used by pharmacy to list every IV and epidural drug found in the pharmacy's formulary, along with associated care areas and infusion parameters for each drug entry.

2 MDL Transfer

Accomplished by:

- Transfer from a wireless network connection to a pump using a wireless battery module
- Transfer from the PC to a mobile PDA and then transfer by infrared from the PDA to a pump

3 SIGMA Spectrum Infusion Pump (Fig 1)

4 Standard Gravity IV Sets (containing a slide clamp used for door opening) (Fig 2)

Cautions and Warnings

For other essential conditions of use, general warnings and operator preparation see "SETUP AND OPERATION", "ALARMS" and "CAUTIONS and WARNINGS" section in this manual

SYMBOLS



Attention, consult ACCOMPANYING DOCUMENTS



CLASS II EQUIPMENT



TYPE BF APPLIED PART

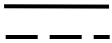

Direct current



ON (only for part of the EQUIPMENT)

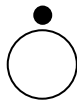

OFF (only for part of the EQUIPMENT)

*** Note: to completely disconnect the equipment from the external power, unplug the AC Power Adaptor from the receptacle.**



Recyclable, dispose of properly



These symbols are on the Battery Pack and are used to identify polarity of the battery. This is for reference only.

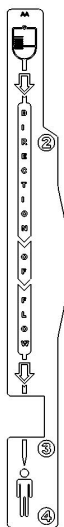

This is a representation of the **Direction of Flow** label (not to scale). This label appears behind the door of the pump. It is intended to assist the user in determining the direction of fluid flow from the medication container to the patient. The fluid direction is controlled by the pumping mechanism when the door is closed and the pump is in the infusion mode (running).



Non-ionizing electromagnetic radiation

ILLUSTRATIONS

Front View – Door Open

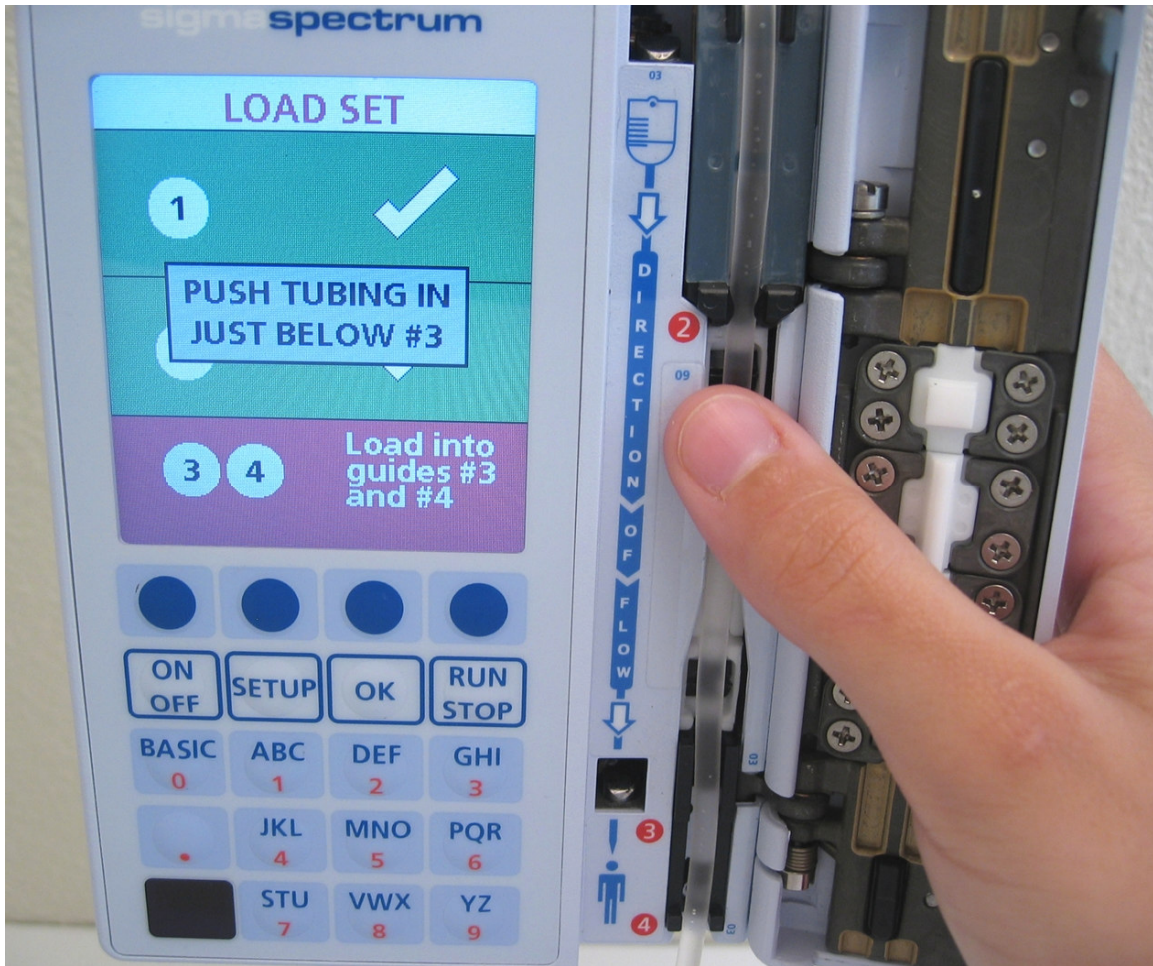

Front View – Pump Running with Standard Battery



Front View – Pump Running with Wireless Battery Module

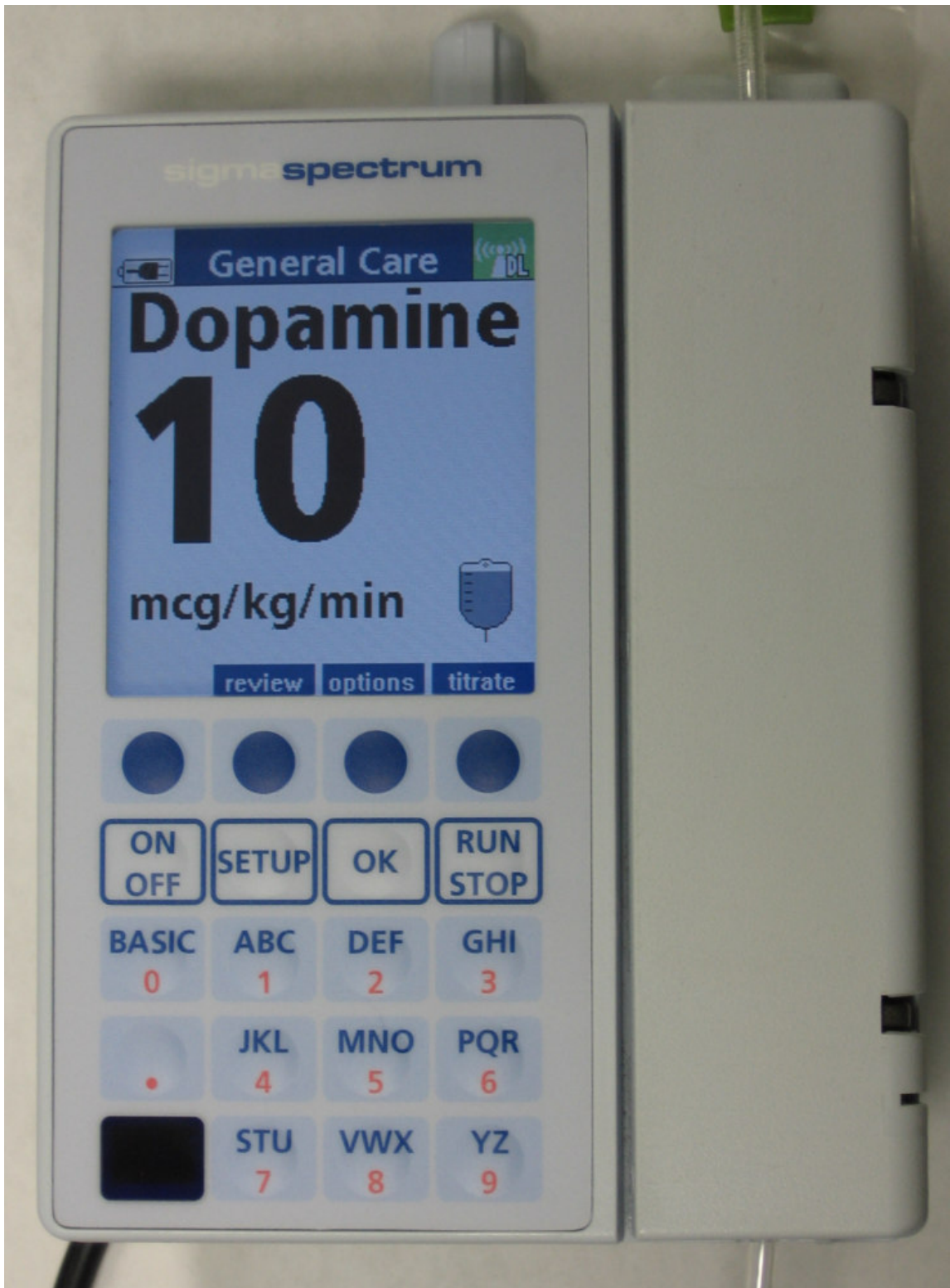

Back View- With Standard Battery



Back View- With 802.11b Wireless Battery Module (P/N 35083)



Back View- With 802.11b/g Wireless Battery Module (P/N 35162)



SETUP AND OPERATION

Keys

- SOFT KEYS (the top row of keys on the keypad) are non-labeled keys with various functions depending on what is displayed above them.
- ARROWS advance cursors and select alternate choices.
- HELP selects photo instructions for things such as door opening / set loading.
- OK confirms entries and advances cursors.
- SETUP starts programming.
- LETTERS are selected by pressing corresponding numerical keys once, twice or three times quickly.
- BASIC allows selection of mL/hr setup (bypassing the Drug Error Prevention system). From BASIC, dose rate modes and ramp/taper modes may also be selected.
- CLEAR erases the highlighted entry.
- CLEAR PROGRAM allows selective clearing of primary mode, secondary mode or both.
- PROGRAM SECONDARY allows access to the drug set up screen for a secondary infusion.
- REVIEW PROGRAM displays set up screen when pump is stopped.
- REVIEW PRIMARY/REVIEW SECONDARY allows viewing/editing of values in set-up screen.
- SILENCE quiets the audio alarm for 2 minutes. Additionally, any key can be pressed for silence.
- HOLD places the pump in standby mode.
- ON/OFF turns the pump on or off.
- RUN/STOP starts and stops the infusion.
- OPTIONS allow the user to select additional pump features.
- BACK allows the user to go back.
- RESET resets multi-step and cyclic TPN programs to the start.
- Multi-Step allows access to the Multi-Step Programming Mode.
- CLR STEP clears one step of Manual Programming Mode.
- TITRATE allows flow rate changes without stopping the pump.
- BOLUS allows Bolus Setup without stopping the pump.

- TAPER DOWN – allows a cyclic TPN program to taper down automatically.
- REVIEW pulls up the set up screen without stopping the pump.

Pre-Pump Programming

- MOUNT THE PUMP to an IV pole.
- Plug the pump into a wall outlet if available.
- IV SETS: select only IV sets made by the manufacturer listed on top of the pump. IV sets must be of standard stiffness and diameter. Performance can not be achieved using stiff, large or small diameter tubing. Contact SIGMA for compatible standard IV set lists and for special SIGMA blood, nitroglycerin and lipid sets.
- PUMPED-ON TUBING should not be re-loaded into the pumping channel (to avoid nuisance alarms and to maintain flow rate accuracy).
- PREPARE IV CONTAINERS AND PRIME IV SETS by positioning roller clamps below the pump, positioning slide clamp near the keyhole at the top of the pump, inverting bags that need to be mixed (rather than shaking them), warming IV solutions to room temperature before use, filling drip chambers approximately halfway and using standard gravity IV set priming technique to purge air from sets and all Y sites.

AC Power Adaptor

WARNING USE ONLY THE POWER ADAPTOR SPECIFIED FOR THIS EQUIPMENT. USE OF OTHER POWER ADAPTORS MAY CAUSE PERSONAL INJURY OR DAMAGE TO EQUIPMENT.

The power adaptor is used to charge the pump's battery. The power adaptor uses a locking cord connection to prevent inadvertent disconnection. To engage the power adaptor, align the arrow of the power adaptor cord with the arrow on the connector identified as the external power adaptor connection (on the back of the SIGMA Spectrum pump). Insert the power adaptor module into the appropriate wall power outlet. The Spectrum will display a plug symbol if the power adaptor is working properly when the pump is in operation. The green led on the power adaptor should be on when the adaptor is plugged into a powered wall outlet.



The Adaptor (power supply) side of the A.C. Power Adaptor is equipped with a Protector (P/N 45742). The Protector is a plastic enclosure which snaps onto the Adaptor. The purpose of the Protector is to protect the Adaptor from damage during use in hospital environment. The A.C. Power Adaptor with the Protector can be used on wall outlet and Pole Mount power strip receptacles. The Protector comes installed with the pump. The Protector cannot be removed from the Adaptor once it is installed. The Protector can be ordered separately as an accessory for installing on old A.C. Power Adaptor. A separate instruction bulletin on how to install the Protector will be send along with the Protector.

The Protector is compatible with the cleaners mentioned in this Operators manual. Refer to the Cleaning & Storage section of this Operators manual for the methods of cleaning and compatible cleaners that can be used on the A.C. power Adaptor with Protector.

NOTE: IMPROPER REMOVAL MAY DAMAGE THE POWER ADAPTOR. Remove the Power Adaptor by grasping the handle of the Protector and pulling it back from the receptacle in a straight direction as shown in figure.

Do not pull the Adaptor at an angle to avoid bending of the prongs. Do not pull the cord to unplug the Adaptor from the receptacle. Improper twisting or pulling of the connector or cord may damage the power supply.

NOTE: Repeated drops of power adaptors on floors will cause them to malfunction. As with all electronic devices, drops should always be prevented.



Set Loading (Unloading)

WARNING THE PUMP WILL INDEX WHEN THE SET'S SLIDE CLAMP IS REMOVED FROM THE PUMP'S KEYHOLE. THIS WILL PROPEL FLUID (MAXIMUM OF .1ML) IN THE IV SET IN THE DIRECTION OF FLOW AND POSSIBLY TO THE PATIENT. THIS WILL OCCUR IF THE ADMINISTRATION SET IS LOADED IN THE PUMP AND A PATIENT IS CONNECTED TO THE ADMINISTRATION SET.

- OPEN THE PUMP DOOR by inserting the slide clamp into the keyhole (loading point #1) and pressing down until the door opens.
- LOAD IV SET TUBING INTO THE TUBING CHANNEL. Loading must be from the top to bottom of the tubing channel and the tubing should be taught. Load the tubing into loading point #2 and then loading points #3 and #4.
- CLOSE THE DOOR by pressing the upper and lower corners near the door hooks areas.
- OPEN THE SLIDE AND ROLLER CLAMP.
- TO UNLOAD SETS, close roller clamp, push the slide clamp in the keyhole until the door opens and pull tubing out from the bottom of the pump towards the top.
- PREVENT FREE FLOW whenever the pump door is open and when the set is out of the pump. This is accomplished by having the set's slide clamp or roller clamp fully closed or by partially opening the roller clamp to achieve gravity flow.
- WHEN CHANGING IV SETS OR CONTAINERS always keep the roller clamp fully closed, (except when following standard gravity set priming procedures).

Drug Error Prevention Programming

- Turn the pump ON.
- Select the care area (nursing area). Press OK.
- Type the drug's first two letters (all drugs beginning with those two letters will appear). Press OK. Scroll to the desired drug. Press OK
- Select the correct drug concentration (if more than one is offered). Press OK. If the "Concentration Confirmation" option is enabled, a dialog shall appear prompting confirmation of the selected drug concentration. Press "yes" to continue or "no" to reselect. Note that the confirmation dialog will appear only when selecting from a list of concentrations or if entering a concentration manually to a drug that has been assigned a "variable" concentration in the Master Drug Library (MDL).
- When the setup screen appears:
 - Confirm the drug and concentration is correct.
 - Select primary or secondary bag and press OK¹.

- Enter all required data. Press OK after each entry.

¹The bag selection prompt shall not be offered if the selected drug has been specifically assigned to either the primary or secondary bag in the MDL.

- Press RUN to begin the infusion. Confirm that all infusion parameters are as intended.
 - Confirmation that drops are flowing is required for SW versions 6.01 and later.

SW V5.02.03 and earlier versions	SW V 6.01 and later
<i>Dose Rate Limits</i>	
<ul style="list-style-type: none"> - SOFT DOSE RATE LIMITS may be exceeded by pressing OK twice (once to enter the value and again to accept the limit warning) thereby providing a double confirmation. 	<ul style="list-style-type: none"> - SOFT DOSE RATE LIMITS may be exceeded by pressing OK followed by pressing the “YES” softkey to accept or the “NO” softkey to decline the dose rate displayed in the dialog box.
<ul style="list-style-type: none"> - HARD DOSE LIMITS can not be exceeded. Reset rates within HARD limits to start the pump. 	<ul style="list-style-type: none"> - HARD DOSE LIMITS can not be exceeded. Reset rates within HARD limits.
N/A	<ul style="list-style-type: none"> - RATE ADVISORY – dose or mL/hr rate entered is increased or decreased by a % (set in Master Drug Library) above or below the current rate. Press “YES” to accept or “NO” to decline the change displayed in the dialog box. In BASIC mode the default rate advisory is set at 101% and cannot be changed. <p>The rate advisory will be 500% if the selected care area name contains “Anesthesia” or “OR”</p>
<i>Basic Programming</i>	
<ul style="list-style-type: none"> - Turn the pump ON. 	<ul style="list-style-type: none"> - Turn the pump ON.
<ul style="list-style-type: none"> - Press BASIC. 	
<ul style="list-style-type: none"> - If the prior setup needs to be erased, press CLEAR ALL. 	<ul style="list-style-type: none"> - If the prior setup needs to be erased, press CLEAR ALL.
<ul style="list-style-type: none"> - When the BASIC screen is displayed 	<ul style="list-style-type: none"> - Select care area, press OK - Type BA to select Basic, press OK
<ul style="list-style-type: none"> • Select primary or secondary bag. Press OK. 	<ul style="list-style-type: none"> • Select primary or secondary bag using arrow key. Press OK.
<ul style="list-style-type: none"> • Select mL/hr or use ARROW soft keys to scroll through dose rates. Press OK. 	<ul style="list-style-type: none"> • Select mL/hr or use ARROW soft keys to scroll through dose rates. Press OK.
	<ul style="list-style-type: none"> • If a dose rate is chosen, enter drug concentration and diluent (mL) values
<ul style="list-style-type: none"> • Enter the flow rate value. Press OK. 	<ul style="list-style-type: none"> • Enter the dose or flow rate value. Press OK.
<ul style="list-style-type: none"> • Enter the VTBI (Volume To Be Infused) in mL. Press OK. 	<ul style="list-style-type: none"> • Enter the VTBI (Volume To Be Infused) in mL. Press OK.
<ul style="list-style-type: none"> • Confirm the computed infusion time. 	<ul style="list-style-type: none"> • Confirm the computed infusion time.
<ul style="list-style-type: none"> • Confirm the Volume Given mL value (or press CLEAR to erase it). 	<ul style="list-style-type: none"> • Confirm the Volume Given mL value (or press CLEAR to erase it).
<ul style="list-style-type: none"> • Note: VTBI counts down to zero, while VOLUME GIVEN counts from zero up. 	<ul style="list-style-type: none"> • Note: VTBI counts down to zero, while VOLUME GIVEN counts from zero up.
<ul style="list-style-type: none"> - Press RUN to begin the infusion. <ul style="list-style-type: none"> • Confirm all infusion parameters are as intended. 	<ul style="list-style-type: none"> - Press RUN to begin the infusion. Check flow displays for rates less than 25 mL/hr - Press “YES” if drops are flowing, all clamps are open, no kinks in tubing. - Press “NO” if no drops flow. Open all clamps and unkink tubing. Confirm all infusion parameters are as intended.
<ul style="list-style-type: none"> - Review/Reprogramming a Primary Infusion 	<ul style="list-style-type: none"> - Review/Reprogramming a Primary Infusion

SW V5.02.03 and earlier versions	SW V 6.01 and later
<ul style="list-style-type: none"> - Running and Stopped <ul style="list-style-type: none"> • Press review soft key to view and or change highlighted value and clear volume given mL. 	<ul style="list-style-type: none"> - Running <ul style="list-style-type: none"> • Press review soft key to view infusion information and clear volume given mL.
	<ul style="list-style-type: none"> - Stopped <ul style="list-style-type: none"> • Press review/program soft key to display set up screen and change any value • Press program secndry softkey to program secondary infusion
Secondary Infusion	
<ul style="list-style-type: none"> - Prepare primary and secondary bags and IV sets (see “Secondary Infusions” under HELP for photo instructions). 	<ul style="list-style-type: none"> - Prepare primary and secondary bags and IV sets (see “Secondary Infusions” under HELP for photo instructions).
<ul style="list-style-type: none"> • Use a primary set with an upper Y site and back check valve. 	<ul style="list-style-type: none"> • Use a primary set with an upper Y site and back check valve.
<ul style="list-style-type: none"> • Connect the secondary set to the primary set’s upper Y site. 	<ul style="list-style-type: none"> • Connect the secondary set to the primary set’s upper Y site.
<ul style="list-style-type: none"> • Using a drop hook, lower the primary bag approximately 20 inches below the secondary bag to provide the secondary bag with a gravity advantage. This causes the primary set’s back check valve to close, which ensures secondary flow. When the secondary bag empties, the primary back check valve opens and primary fluid begins to flow. 	<ul style="list-style-type: none"> • Using a drop hook, lower the primary bag approximately 20 inches below the secondary bag to provide the secondary bag with a gravity advantage. This causes the primary set’s back check valve to close, which ensures secondary flow. When the secondary bag empties, the primary back check valve opens and primary fluid begins to flow.
<ul style="list-style-type: none"> - Program the pump for the primary bag as described above. 	<ul style="list-style-type: none"> - Program the pump for the primary bag as described above.
<ul style="list-style-type: none"> - Then press SETUP to begin programming the secondary bag. 	<ul style="list-style-type: none"> - Press program secndry softkey to begin programming the secondary bag.
<ul style="list-style-type: none"> - If a drug is to be delivered in the secondary program (drug must be pharmacy / hospital-approved for delivery as a secondary line), enter the drug name by typing the drug’s first two letters. Scroll to the desired drug. Press OK. 	<ul style="list-style-type: none"> - If a drug is to be delivered in the secondary program (drug must be pharmacy / hospital-approved for delivery as a secondary line), enter the drug name by typing the drug’s first two letters. Scroll to the desired drug. Press OK.
<ul style="list-style-type: none"> - Otherwise press BASIC and use the soft key ▲▼ to change the bag to “Secondary”. Press “OK” and select mL/hr or dose rate mode. 	<ul style="list-style-type: none"> - Press OK to select secondary bag or use ▲▼ softkey to change to primary bag
<ul style="list-style-type: none"> - When the setup screen appears: 	<ul style="list-style-type: none"> - When the setup screen appears:
<ul style="list-style-type: none"> • Confirm the drug and concentrations are correct (if selected). 	<ul style="list-style-type: none"> • Confirm the drug and concentrations are correct (if selected).
<ul style="list-style-type: none"> • A “watermark” indicator will be displayed behind the parameter data to help distinguish the Secondary (2) setup screen from the Primary (1) setup screen. 	<ul style="list-style-type: none"> • A “watermark” indicator will be displayed behind the parameter data to help distinguish the Secondary (2) setup screen from the Primary (1) setup screen.
<ul style="list-style-type: none"> • Note that this watermark shall not appear on Primary-only infusions. 	<ul style="list-style-type: none"> • Note that this watermark shall not appear on Primary-only infusions.
<ul style="list-style-type: none"> • Enter all required data. Press OK after each entry. 	<ul style="list-style-type: none"> • Enter all required data. Press OK after each entry.

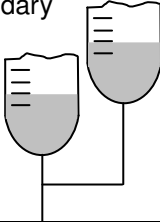
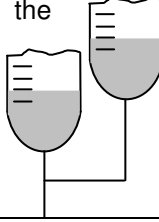
SW V5.02.03 and earlier versions	SW V 6.01 and later
<ul style="list-style-type: none"> To avoid infusing residual amounts of the secondary container at primary flow rates, be sure to properly set the secondary VTBI value. Secondary VTBI should equal secondary bag volume. 	<ul style="list-style-type: none"> To avoid infusing residual amounts of the secondary container at primary flow rates, be sure to properly set the secondary VTBI value. Secondary VTBI should equal secondary bag volume.
<ul style="list-style-type: none"> Press RUN to begin the secondary infusion. A “two bag” icon denote the secondary is running. 	<ul style="list-style-type: none"> Press RUN to begin the secondary infusion.
<ul style="list-style-type: none"> Open the secondary set’s roller clamp when prompted. Press OK again to confirm accomplishment of that step and begin delivery. 	<ul style="list-style-type: none"> CHECK FLOW – Confirm flow (yes/no) from the secondary drip chamber.
<ul style="list-style-type: none"> If the secondary rate is above 300 mL/hr, a dialog box appears prompting observation of the primary drip chamber. 	<ul style="list-style-type: none"> YES – Secondary infuses as programmed until completion with automatic transition to primary.
<ul style="list-style-type: none"> If drops are seen, the primary line should be clamped closed. Press “yes” in this dialog box if a clamp is being applied to the primary line. Upon completion of the secondary infusion, the pump will enter a KVO state and it will ask for the removal of the clamp from the primary line. Press OK once the clamp has been removed to clear the alert and begin the primary delivery. 	<ul style="list-style-type: none"> NO – Hang secondary bag above primary bag, confirm secondary clamp is open and flow from the secondary container, the Press yes or no softkey
<ul style="list-style-type: none"> Press “no” in the dialog if drops are not observed in the primary drip chamber. 	<ul style="list-style-type: none"> YES – Secondary infuses as programmed until completion with automatic transition to primary
	<ul style="list-style-type: none"> NO – Apply clamp to primary line above upper y site. Press OK to confirm primary is clamped.
	<ul style="list-style-type: none"> A “two bag” icon denote the secondary is running. 
	<ul style="list-style-type: none"> If primary line is clamped, the secondary infuses until completion. The rate will decrease to a KVO with alarm.
	<ul style="list-style-type: none"> Press STOP.
	<ul style="list-style-type: none"> Press the SECONDARY softkey to return to Secondary setup – Allows reprogramming of the secondary infusion
	<ul style="list-style-type: none"> Press the begin PRIMARY softkey to return to Primary infusion – Remove

SW V5.02.03 and earlier versions	SW V 6.01 and later
	clamp from Primary and press OK to begin primary infusion.
	<ul style="list-style-type: none"> - CHECK FLOW – Confirm flow from primary drip chamber (yes/no) - YES – Primary infuses as programmed. - NO – Close clamp on secondary line. Press OK to confirm secondary line is clamped.
<ul style="list-style-type: none"> • Upon completion of the secondary infusion, transition to the primary infusion shall be automatic and a “one bag” icon shall replace the “two bag” icon on the RUN screen. 	<ul style="list-style-type: none"> • Upon completion of the secondary infusion, once the transition is made to the primary infusion, a “one bag” icon shall replace the “two bag” icon on the RUN screen.
<ul style="list-style-type: none"> • Note: Upon completion of the secondary infusion, the clamp on the secondary set should be closed to prevent any remaining fluid in the secondary bag being delivered at the primary delivery rate. 	<ul style="list-style-type: none"> • Note: Upon completion of the secondary infusion, the clamp on the secondary set should be closed to prevent any remaining fluid in the secondary bag being delivered at the primary delivery rate.

RETURNING to the primary mode while infusing in a secondary mode (SW V 6.01 and later)

- Press STOP
- Press Clear Program softkey
- Press secndry softkey
- Press yes softkey
- Close clamp on SECONDARY line above the upper y-site or remove Secondary container and tubing (see Caution below)
- Press OK to continue
- The primary review screen appears
- Press RUN to start the primary infusion

CAUTION: Close the clamp on the Secondary line or remove the Secondary container administration to prevent the secondary medication from flowing when the Primary mode is intended.

SECONDARY CALLBACK – Assigned to a secondary drug in the MDL (SW V6.01 and later)

- Pump will stop (KVO rate) and a callback alarm will occur when the secondary infusion completes.
- Press STOP at completion (KVO)
- Return to Secondary setup or Return to Primary infusion

Loading Dose Programming (SW V6.01 and later)

- A loading dose is selected in the MDL (Master Drug Library) and infuses at the beginning of an infusion.
- A loading dose amount, time and limits are assigned to drugs in the MDL.
- A loading dose icon (syringe) is displayed next to the “Primary or Secondary Bag” line on a completed set up screen.
- After all infusion values are entered, a loading dose dialog box displays: “Do you want to deliver a Loading Dose from the PRIMARY (or SECONDARY) bag? (yes/no)
- If yes, loading dose set up screen displays.
- Enter all required data. Press OK after each entry.

- Press RUN to start loading dose delivery.
- CHECK FLOW (yes/no)
- At the completion of the loading dose, transition to the primary infusion rate shall be automatic.

Bolus Programming (SW V6.01 and later)

- A bolus may be delivered in basic mode or as selected in the MDL (Master Drug Library).
- A bolus amount, time and limits are assigned to drugs in the MDL.
- A bolus may be programmed while the pump is stopped or infusing by pressing the bolus soft key.
- Enter all required data. Press OK after each entry.
- Press RUN to start bolus delivery.

At the completion of the bolus, transition to the primary infusion rate shall be automatic.

Manual /Multi-Step: (Ramp soft key- SW 5.02.03 and earlier), (Multi-Step soft key- SW 6.02 and later) Programming Mode

- The Manual (RAMP/Multi-Step) Programming Mode allows the pump to be programmed with up to 10 individual infusion steps using either the Drug Error Prevention or Basic Programming Operations. Drugs are eligible for use in the Manual Programming Mode, provided that the selected drug has not been specifically assigned to either the primary or secondary bag as identified in the pump's Master Drug Library.
- Initial programming is similar to the descriptions for Basic or Dose Error Prevention (SETUP) modes. At the primary bag selection of the programming, the RAMP/Multi-Step soft key will be displayed allowing access into the Manual Program Mode. Press RAMP/Multi-Step to enter Manual Program Mode.
 - *Note that Manual Program Mode is not available in Secondary Bag or in Primary Bag when a secondary program exists in memory.*
- With Manual Program Mode entered, setup again continues as described in the Basic or Dose Error Prevention programming sections.
- A step indicator bar is located at the top of the screen. The bar shows which steps within the program have parameter data (a small white highlight) and which step is currently being viewed (a full white highlight)
- Once setup of an individual step has been completed, press OK to advance and program the next step. When the 10th step has been programmed, the program schedule is complete and no more steps may be programmed.
- Only one step is necessary to start a program however it must be the first and only programmed step. The pump may not be started if setup data is missing from any step in the program. Any parameter data missing within the program shall be identified in a popup message when a program attempts to be started.
- The setup data for any programmed step may be viewed by moving the highlight (using the up ARROW soft key) to the step indicator bar located at the top of the setup screen and then using the left and right ARROW soft keys to move from step to step.
 - Note that a one-second delay exists from the time a step is selected and when its setup data is displayed. This delay is to allow rapid scrolling along the step bar without updating the screen contents repeatedly and unnecessarily.

- If the pump is stopped, any setup data may be changed by navigating to that step and pressing OK to move to the values that must be changed. If the pump is running, any programmed step may be viewed by pressing the REVIEW soft key but no values may be changed with the exception of the Volume Given value which may be cleared by pressing the CLEAR soft key.
- Press RUN to start the program.
 - RUN screens appear as described in the mL/hr or Dose Error Prevention programming sections with the addition of a program step indicator shown in the "Step x of y" format, where x is the current step being delivered and y is the total number of programmed steps.
 - When the program completes and the STOP key is pressed, the program schedule automatically resets (Note: Always verify current program parameters for each step prior to starting a new infusion) itself and may be restarted without entering/reentering any setup data. The program will be retained indefinitely during power off cycles until reset. To reset the program press the RESET soft key from the PROGRAM STOPPED screen.
- To clear the entire program, press the CLEAR PROGRAM soft key and answer YES to the confirmation screen.
- To clear the setup data from any individual step, the pump must be stopped. Move the highlight to the desired step in the step bar and press the CLR STEP soft key. Note that clearing a step does not delete that step unless it is the last step in the program.

Cyclic TPN Mode – Software Version 6.02 and Later

The cyclic TPN mode is designed to deliver TPN in an automatic ramp up, main rate and taper down program. The infusion schedule is calculated with the rates and volumes for 10 ramp steps up occupying 10% of the total infusion time, 10 taper down steps occupying another 10% and the main rate accounting for the remaining 80% of the infusion time.

To program cyclic TPN:

- Select cyclic TPN from drug list
- Enter program VTBI. Press OK.
- Enter program time. Press OK.
- View display screen with Main Rate, VTBI, prog time, Ramp up time, Main rate time and taper down time.
- Press Run to start infusion.
- Observe mL remaining value and green infusing icon.
- Press review soft key to display program status.
- To begin early taper down, press taper down soft key.
- At completion, pump infuses at KVO. Press stop to automatically reset the program from the beginning.
- Once the TPN program starts delivery, no changes to the infusion parameters can be made.

Titration – Software version 5.02.03 and earlier

- To titrate flow rates without stopping the pump (not available in Program Modes):
 - Press TITRATE.
 - Observing the displayed hard and soft rate limits, enter a new flow rate.
 - Press either RUN or OK.

Titration – Software version 6.01 and later

- ***To titrate flow rates and VTBI without stopping the pump***
 - ***Press Titrate soft key***
 - ***To titrate dose, press dose soft key***
 - ***To titrate rate mL/hr, press mL/hr soft key***
 - ***Observing the displayed hard and soft dose or mL/hr/flow rate limits, enter a new dose or mL/hr/ flow rate.***
 - ***Press OK. If soft limits are exceeded, Press YES to accept new value or NO to return to prior value.***
 - ***To titrate VTBI, press VTBI soft key, enter new value. Press OK.***

Patency Checks

- To confirm the IV line is not blocked:
 - Press STOP.
 - Open the door.
 - Slowly open the roller clamp to check for gravity flow. If gravity flow can not be achieved, a clamp is closed, the tubing is kinked, the catheter is blocked or a filter may be clogged.

Keypad Lock Operation

Auto keypad lock off

- To lock the keypad the caregiver should enter the code 429 (“K”, “E”, “Y”). This code is entered when the pump is in the run mode to prevent unauthorized activation of specific key entries. A popup message shall be displayed briefly indicating the keypad has been locked. The Key lock icon is shown on the top left corner of the screen. 
- The REVIEW soft key may be pressed to allow review of the infusion setup data. No values may be changed and therefore navigation from value to value is not allowed when the keypad is locked.
- The keypad will allow certain alarm conditions to be silenced and cleared while in the Keypad Lock mode.
- The code must be re-entered to unlock the Keypad. If the keypad is unlocked while reviewing the setup data and the pump is running, as long as the pump is not stopped the keypad will automatically relock upon return to the RUN screen.

Auto keypad lock on

- Turn ON in the Master Drug Library per care area
- Keypad lock code is set hospital wide and may be 1 to 4 digits (1-9 only, zero can not be used)
- Keypad will be automatically locked 60 seconds after the run key is pressed
- Passcode must be entered on the keypad to unlock

CAUTION: Always guard the keypad lock code from unauthorized view or access. Uncontrolled access by a patient or family member may possibly cause injury to the patient.

Pump Standby (Hold Mode)

- The pump may be placed in a standby state to prevent the occurrence of the Inactivity Alarm (see ALARMS) for the period of time specified in the User Settings / Alarm Settings menu option. The default setting is to provide an infinite period of time however this value may be changed from one minute up to 99 hours and 59 minutes.
- For Standby Mode to be available the set must be loaded and the infusion setup must be complete.
- Once setup has been completed and the highlight is on the *Volume Given mL* value, a display will appear stating that the pump may either be started or it may be placed in standby mode. To place the pump in standby, press the HOLD soft key.
- When standby is activated, the indicated message will be displayed in a flashing format. Note that if the delay period is set to infinite, the time value in the display will be replaced with a dashed line.
- While in standby, the user may press RUN at any time to begin the infusion. Pressing any other key or opening the pump door will cancel standby mode.
- Pump Standby may also be used when the pump is stopped in a non-alarm condition. Press the review/program soft key and then press the HOLD soft key from the SETUP screen.

**IN STANDBY
01:00 (hr:min)
Push RUN
to start pump**

Delayed Start

- Selected per drug in the Master Drug Library
- The start of any programmed infusion may be delayed by up to 12 hours. On the infusion set up screen, enter any value between one minute and twelve hours (00:01 – 12:00, hr:min) on the delay time parameter and press OK.
- Once a delay time is entered the infusion program completed and the set is loaded, the RUN key may be pressed to begin the infusion delay timer. The screen shall update to a DELAY RUNNING display with the remaining delay time shown in a flashing format.
- While the delay is running it may be stopped by pressing the STOP key (display updates to DELAY STOPPED and the delay timer is paused and no longer flashes) or it may be cancelled by pressing the CANCEL soft key (remaining delay time is cleared and the display updates to PUMP STOPPED).
- The remaining delay time value may be changed while the delay is running or stopped. From the setup screen (press review/program softkey if the delay is running) move the cursor to the Delay value and enter the new desired delay time and press OK. The new delay time shall be immediately observed.
 - *Note: the Delay time value may not be cleared while the delay is running.*
- When the delay time period expires, the pump shall begin delivery of the programmed infusion.

ALARMS

Air-in-Line

- Press OK and then press RUN to advance small bubbles past the air detector. Each press of RUN advances approximately 0.1 mL. Use a syringe to aspirate air from the lower Y site or re-prime the set.

Audio

- May be silenced for 2 minutes by depressing any key.
- Low, medium and high volume levels may be selected in the CONFIG screen.

Depleted Battery

- The battery is fully depleted and unable to run the pump. To continue the infusion and recharge the battery by plugging the pump's AC power adaptor into an AC outlet. Confirm that the adaptor's power cord connector is attached to the pump.

Door Not Fully Closed / Set Outside Channel

- The pump's door has not closed and latched correctly. Ensure the slide clamp is closed, open the door using the slide clamp and re-load the IV set. Close the pump's door ensuring both door latches shut securely.

Door Open

- The slide clamp has been closed and inserted in the keyhole when the pump was running. The pump is stopped. Close the door, open the slide clamp, remove it from the keyhole and press RUN to restart the infusion OR open the door and unload the IV set.

Downstream Occlusion

- Eliminate a closed clamp, kinked tube, positional catheter, clotted catheter, clogged IV filter or other sources of occlusion below the pump and the pump will restart automatically.

Downstream Pressure Limit – Reset Setting

- Downstream pressure limit differs from care area default (set in Master Drug Library). Select Yes to reset or No to keep the current setting

Infusion Complete

- The VTBI (volume to be infused) has counted down to zero and has been delivered. The pump is running at a rate of 1.0mL/hr (KVO rate) – keep vein open (or the actual infusion rate, whichever is lower). Press STOP to halt the KVO rate and return to the Setup Screen. Select a new VTBI value and press RUN.

Inactive Alarm

- The pump has been inactive for 2 minutes and no action has been taken. Follow the prompted action and resume or restart the pump by pressing Run.

In Stop – Slide Clamp Closed

- Open slide clamp and push RUN (or unload set)

Low Battery

- The low battery alarm threshold has been reached. Plug the AC Power Adaptor into the pump and into the AC source outlet as soon as possible to recharge the battery.

Very Low Battery

- Less than ½ of the low battery capacity remains. The AC Power Adaptor should be plugged in immediately. The tutorial to check the AC Power Adaptor will automatically begin (see Appendix B for details).

Battery Missing

- Battery not detected. Check to make sure it is fully latched.

Shut Door

- Shut the pump door and either press RUN to start the infusion or press OFF. Power will not turn off with the door open.

Slide Clamp Closed

- Open slide clamp and press run or reload the set.

System Error

- An internal fault has been detected. Some faults can be cleared by either cycling power (off then on) or by turning the power off, disconnecting the battery, reconnecting it several seconds later and pressing the ON key. If neither procedure clears the fault return the pump for service.

Upstream Occlusion

- Eliminate the occlusion by checking for an upstream closed clamp, kinked tube or closed burette valve and press the RUN key.

TIPS

Prevent Nuisance Alarms

The following steps will help to prevent nuisance alarms:

- Remove all air from IV sets and Y sites.
- Do not administer extremely cold or hot solutions. Warm solutions to room temperature before use to help prevent nuisance upstream occlusion or air-in-line alarms caused by out-gassing of micro bubbles.
- Do not use effervescent, foamy or frothy solutions.
- Invert (do not shake) IV bags that need to be mixed.
- Fill drip chambers half way.
- Do not load pumped on IV set tubing in the pumping channel or in the air and occlusion detector areas.
- Follow prompts and HELP screens.
- Use only compatible IV sets as labeled and identified on the SIGMA pump.
- Keep the tubing channel clean and dry.
- Avoid empty IV containers by properly setting VTBI values.
- Plug pump's AC power adaptor in to maintain battery charge.
- Using the Low Downstream pressure setting at flow rate setting above 500 mL/Hr may cause Downstream nuisance alarms that are created by I.V. set pulsation.

Managing Bolus before Occlusion (Downstream) Release

- MANAGING UNINTENDED SMALL BOLUS RELEASES WHEN CLEARING DOWNSTREAM OCCLUSIONS

When a downstream occlusion alarm occurs, pressure and a small volume of <0.98 mL of fluid (the "bolus") builds up between the pump and the point of occlusion. When it might be harmful to infuse the bolus into the patient, simultaneously withdraw 0.9 mL of fluid from the lower "Y" site of the IV set and eliminate the source of the occlusion.

WARNINGS AND CAUTIONS

WARNING Operation is Limited to Trained and Tested Operators
SIGMA Spectrum operation is strictly limited to trained operators whose competency in safe Spectrum operation and in safe IV therapy practices has been tested and proven. Pump owners have sole responsibility for operator training and testing even when SIGMA personnel assist in training processes.

WARNING Confirm Safe Operation at Start and Thereafter
Confirm safe, accurate pump operation at start and periodically thereafter by:

- Confirming there is no drip chamber flow when the pump is stopped.
- Confirming the drop rate approximates the pump's flow rate during RUN operation.
- Confirming pump settings are as intended.
- Confirming correct: patient, route, dose, time and drug/concentration.
- Regularly observing that the patient's vital signs and IV site are in good condition. Note that infiltrations can not be detected by IV pumps. They must be detected by clinicians and minimized. The Spectrum is not a substitute for regular patient observation.

Never operate the Spectrum unless all of the above safe operations are being practiced.

WARNING Prevent Inaccuracy
The following can cause flow rate inaccuracies and must be avoided:

- Incompatible brand IV sets and compatible brand IV sets with unusually large or small diameters or unusually stiff materials.
- Operating temperatures outside of 60-90°F for Standard Battery and 60-80°F for Wireless Battery Module.
- Using IV sets longer than is recommended in the Specifications section of this manual.
- Using dropped, damaged, dirty or wet pump.
- Pressurizing IV bags.
- Positioning IV containers more than 3 feet above or 1 foot below the pump.
- Microdrip or Minidrip chambers should not be used for flow rate settings greater than 200 mL/hr. Doing so may influence flow rate accuracy and cause nuisance air or upstream occlusion alarms
- When using sets with backcheck valves, flow rate settings should not exceed 500 mL/hr. Doing so may influence flow rate accuracy or cause nuisance upstream air or upstream occlusion alarms. Flow rates above 300mL/hr may cause fluid to be siphoned from the primary container during piggyback operation (see Secondary Infusion)

Note: Upstream occlusion detection is only effective for occlusions present immediately after the start of the pump's run operation. Upstream occlusions caused by non-vented IV sets used with non-vented glass bottles or closed burette air vents cannot be detected because of the very slow building vacuums resulting from these situations.

WARNING This equipment is not suitable for use in the presence of a Flammable Anesthetic Mixture with Air or with Oxygen or Nitrous Oxide. (This statement is a requirement of the IEC—60601-2-24 standard. It applies to oxygen enriched environments, such as oxygen tents. It is not meant to apply to patients on breathing tubes.)

WARNING Follow Epidural Precautions
Epidural administration of drugs other than those indicated for epidural use can result in serious patient injury.

- When administering epidural analgesics, use only catheters specifically labeled for epidural analgesia drug delivery.
- To help prevent accidental infusion of non-epidural drugs, DO NOT USE epidural administration sets that contain injection sites.
- Label the administration container and IV set “EPIDURAL USE ONLY”.
- Clearly identify infusion pumps used for epidural administration.
- Use KEYLOCK.

WARNING Do Not Allow Uncontrolled Gravity Flow
To open the pump door, the IV set’s slide clamp must first be closed (thus providing “set based anti-free flow” protection). Do not open the slide clamp when the door is open or during and after IV set unloading or dangerous uncontrolled free flow can occur. During IV container changes, always close the set’s slide or roller clamp. When the set is in the pump and the door is closed, the slide clamp can be left open. If gravity flow is to be used, the pump door will be open or the set will be outside the pump and you will need to be sure gravity flow is maintained at the intended rate whenever the pump door is open and when the set is outside of the pump.

WARNING Disposal
To dispose of this device or the associated administration sets, adhere to local, state, federal and / or other governing regulation.

CAUTION Use the Specified Manufacturer’s IV Set Type



This label is located on the top of the pump and indicates the specific type of IV tubing that the pump has been calibrated to. The use of other manufacturer’s brands or type tubing may produce pump inaccuracies that may be unsafe for patients.

CAUTION Use Key lock to Avoid Tampering

With auto keypad lock OFF

To lock the keypad after the pump starts running, enter the number 429. The display will indicate “KEYPAD LOCKED”. The keypad is now locked. A lock symbol will replace the display message. To unlock the keypad re-enter 429. During KEYLOCK, parameters can be read but not changed and the pump can not be stopped or turned off.

With auto keypad lock ON

See section on Keypad Lock Operation

CAUTION Follow Neonatal and Pediatric Precautions

- Use 60 drops / 1 mL IV sets.
- Configure the pump with appropriate flow rate, VTBI, patient weight and occlusion alarm limits (using CONFIGURATIONS/Options mode).

- Prior to connecting to patient, prime set, load set, open slide and roller clamp (if equipped) to avoid possible bolus (.2mL) that would result around door opening/set loading event.
- If the pump door is opened with an IV set connected to a patient and bolusing at door closing must be avoided **before closing the door**, clamp the set below the lower Y site, connect a syringe to the lower Y site, close the door, open the slide clamp, collect a 0.085mL bolus in the syringe and unclamp the set below the Y site.

CAUTION “Use of controls, adjustments or performance of procedures other than those specified herein may result in hazardous radiation exposure.”

This caution is to alert the user that altering any part of the scanner or pump may cause light levels to exceed Class 1 limits. Under normal conditions this is not an issue.

CAUTION Use Sound IV Poles
Do not mount pumps on IV poles that allow pump cases to impact floors if poles tip over.

CAUTION Service Personnel Must be Trained at SIGMA
Servicing Spectrum pumps is restricted to qualified, SIGMA trained, service personnel who employ SIGMA authorized parts and procedures. Use of other parts and servicing procedures is prohibited.

CAUTION Perform Preventative Maintenance Annually
Pumps should be tested for proper performance annually and also whenever damage from drops, fluid intrusion and other causes is suspected. See SIGMA Spectrum Service Manual for complete information.

CAUTION Do Not Improperly Clean Pumps
During cleaning, do not allow fluid to seep inside pump (especially through front panel door latch holes or back case speaker holes) or severe damage may occur. Wipe on minimal amounts of cleaning fluids, never spray them. Use only SIGMA specified compatible cleaning fluids. Do not autoclave or ETO sterilize pumps.

CAUTION Be Cautious Near RF Sources
The Spectrum pump meets the electromagnetic compatibility (EMC) requirements as specified in the International Electrotechnical Commission’s (IEC) 60601-1-2 (2001-09) standard for emissions and immunity. It is good practice to keep the pump separated away from other equipment, such as hand held transmitters, cellular phones and electrosurgical equipment that may generate strong radio frequency interference (RFI). Reference the EMC Immunity Section, Separation Distance, in this manual for recommended minimum distance.

CAUTION Confirm Audio Operation
When pressing the ON key and all other keys confirm that an audio beep is heard. If sound cannot be heard, discontinue use of the pump and return to SIGMA for service.

CAUTION Confirm Display Operation
Regularly observe the pump’s display. Discontinue use of the pump and return to SIGMA for service if display abnormalities are observed.

CAUTION Electric Shock Hazard
There are no user serviceable parts. Do not open the case. Refer servicing to qualified service personnel at your institution or return to SIGMA.

CAUTION

Accuracy

Reference trumpet curves for flow rate accuracy as a function of short infusion durations.

The upstream occlusion detector may not detect partially occluded tubing. Always check to ensure the IV set's clamp is not closed above the Spectrum pump.

Small bore catheters or needles may cause excessive backpressure at elevated flow rates. Please size the catheters according to expected flow rate and fluid viscosity.

CAUTION

Follow Physicians Orders

Federal (USA) law restricts this device to sale or use by, on the order of, or under the supervision of, a physician or other licensed healthcare practitioner.

CAUTION

Single Fault Conditions

The maximum downstream occlusion time due to a single fault condition (in seconds) may be determined by dividing 2448 by the flow rate in mL/hr.

In the event of a downstream occlusion detector failure, the secondary detection method will limit the pressure developed by the pump to 10 PSI above nominal setting and generate an audible and visual alarm.

A bolus of approximately 0.5 mL may be generated as a result of a single fault condition.

Air volume equivalent to 15 seconds of delivery may be delivered to the patient in the event of a single fault condition. The amount of undetected air, in mL, is dependent on flow rate setting divided by 360. This air may not reach the patient depending on tubing length from the pump to the patient. One inch of tubing is approximately equivalent to .120mL of fluid.

CLEANING AND STORAGE

The SIGMA Spectrum is portable and it should be cleaned and disinfected for each patient use according to facility protocol.

Examples of Compatible Cleaners:
(Refer to DOC 11318 for Complete Listing)

- 1 10% solution of bleach and water
- 2 Up to 90% Isopropyl alcohol
- 3 Caltech Industries Dispatch®
- 4 Steris TBQ® and Steris Germicidal Surface Wipes, Product Number 1608-GS
- 5 Metrex Cavicide® and Cavi Wipes™
- 6 May be others. Contact SIGMA for additional information

To clean the pump, turn it off and unplug the AC power adaptor from the power source. Place the pump in an upright position (keyhole release upward). Apply the compatible cleaning agent with a dampened cloth per the manufacturers' instructions using appropriate dilution ratio. Disinfectants should remain on the pump's surface in an even, but not dripping film for the compatible cleaning agents' recommended contact time. Open the pump's door using a standard IV set's slide clamp. Clean the speaker vent, power adaptor connector, door release, Keyhole and pumping channel areas with soft swabs. Apply solutions sparingly to the swabs and wipe down the necessary areas. Do not use rigid cleaning instruments or spray solutions directly on the pump and its accessories. **For severe solution spills it is recommended that the Standard Battery/ Wireless Battery Module be removed. The Battery Pack cavity area of the pump may be cleaned by wiping down those regions with a dampened cloth as described previously.** Dispose of all cleaning materials (including the slide clamp) as required per facility protocol/biohazard policy.

CAUTION

- Alcohols are flammable and should not be used for Standard Battery/ Wireless Battery Module cleaning/disinfection. Always use alcohols in a well-ventilated area.
- When cleaning the Standard Battery/Wireless Battery Module, care should be taken to prevent shorting of the pack's exposed terminals.
- Do not sterilize this device by autoclaving or ETO gas.
- Do not immerse any part of this device or allow cleaning fluids to seep inside the pump.
- Do not use phenol-based cleaners/disinfectants. Phenols degrade plastics and membrane switches. Phenols are intended for cleaning of hard non-porous surfaces such as: sinks, counter tops and stainless steel.
- Do not use abrasive cleaners.

Storing

- Connect the AC power adaptor to the pump and supply source power to charge the pump's battery during storage. This will insure a fully charged battery for subsequent use.

- Do not store or transport pumps in ways that might result in physical damage.
- For extended periods of storage remove the battery and repackage the pump in the original shipping container.
- Storage at elevated temperatures will diminish battery life.
- Refer to Specifications section of this manual for recommended storage temperature and humidity.

Battery Disposal



The SIGMA Spectrum contains a Lithium-Ion rechargeable standard battery pack/Wireless Battery Module. It **should not** be disposed of in trash or in fire. It is a recyclable product and should be disposed of properly. Return to SIGMA for disposal if an authorized disposal center cannot be found.

CAUTION

Do not short circuit the battery terminals.

Do not disassemble or modify.

Battery Charging

When the SIGMA Spectrum is connected to the AC Power Adaptor and the adaptor is plugged into a powered outlet receptacle, the pump's standard battery pack or Wireless Battery Module will be charged to full capacity. It is not necessary to turn the pump on.

Refer to Appendix C for a listing of the symbols used and their description

Battery Removal and Replacement

Should removal of the battery become necessary for any reason, the following procedure may be used.

1. Turn unit OFF if ON.
2. Disconnect the AC Power Adaptor, and lay the SIGMA Model Spectrum Pump on its front. Use a protective surface, such as plastic foam, to prevent damage to the keypad window.
3. Remove the screw located in the upper right hand corner of the SIGMA Spectrum Battery (if equipped).
4. Depress the release mechanism found in the top center portion of the battery and pull away from the back of the unit.
5. Install the battery by placing the battery insulation tab over the terminals and then gently sliding the battery down the back of the case and inserting the bottom of the battery into the pocket then pivoting it into the latch. Make sure the latch is engaged to retain the battery. Remove the battery insulating tab prior to charging the pump's battery or operating the pump. Install the retaining screw (if equipped).
6. Plug the AC power adaptor into an outlet to begin charging.

SERVICING

CAUTION Electric shock hazard.

There are no user serviceable parts. Do not remove the case. Refer servicing to SIGMA trained and qualified service personnel. Refer to the Service Manual for inspection and maintenance procedures.

To Return Pumps to SIGMA

- Phone 1-800-356-3454 for a repair authorization (RA) number. A P.O. number for non-warranty repairs is also required.
- Ship pumps to SIGMA 711 Park Avenue, Medina, NY 14103
- Include a problem description, contact person, phone number and return address. Label the shipping box with the RA number. Return pumps in original boxes, with original inserts to prevent damage during shipment.

Required Maintenance and Frequency

- Maintenance consists of routine cleaning and annual performance evaluations as described in the service manual.
- Pumps suspected of being damaged must be tested for proper performance before being returned to patient use. This includes pumps that have been physically damaged, dropped or those that have fluid intrusion.
- A PM or Network expiration due date may be entered in the BIOMED options. A "Due for Inspection" reminder will appear with the power ON display followed by the normal programming screens. At power off, a due for inspection display will appear prior to pump shutdown.

ACCESSORIES

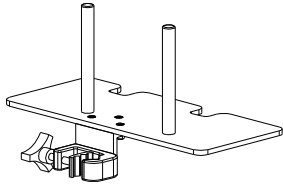

Tandem Carrier
Cat No. 55092NS

- Holds 2 Spectrum pumps
- Stainless up-right tubes and aluminum -plate
- C-Clamp jaw opening expands to 1.5"
- C-Clamp knob comes off if semi-permanent attachment of carrier is desired

3 Pump Carriers
Cat No. 55093

- Holds 3 pumps.
- Stainless up-right tubes and aluminum -plate.
- UL, CSA four outlet power strip for multi pole plug in (1 cord from IV pole to wall outlet).
- C-Clamp jaw opening expands to 1.5".
- C-Clamp knob comes off if semi-permanent attachment of carrier is desired.

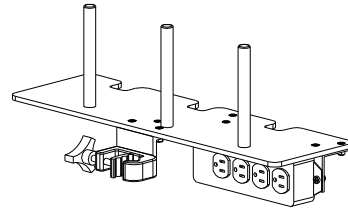

Single-Pole
Cat No. 55096

- Adjustable height stainless steel pole.
- Revolving 4 hook top.
- Stable 5-leg base with 3" casters.

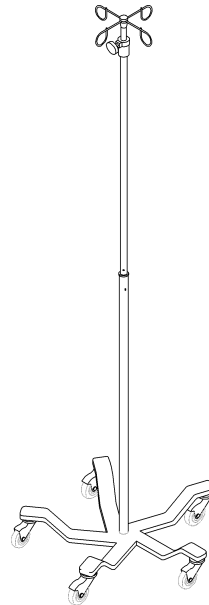

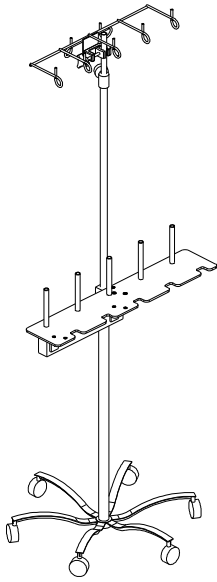

Multi-Pole

Cat No. 55088-1

- Holds 5 pumps.
- Adjustable height stainless steel pole.
- 7 hook top.
- UL, CSA six outlet power strip for multi pole plug in (1 cord from IV pole to wall outlet).
- Heavy-duty 6-leg base with 3" soft rubber casters.
- Patient support ring attached to rear of plate.

CAUTION Securely mount IV pumps to pole by turning the mounting knob clockwise. To maintain IV pole stability never exceed 210 cm (83") from floor to IV pole top and limit bag volume at this extended height to < 1 liter (1000 cc).

A.C. Power Adaptor Protector (also referred to as Protector)

SIGMA Part Number (P/N) 45742

- Snaps on the Adaptor side of A.C. Power Adaptor
- Handle on the Protector helps for easy insertion & removal of Adaptor (power supply) from receptacle.
- Protects Adaptor from damage

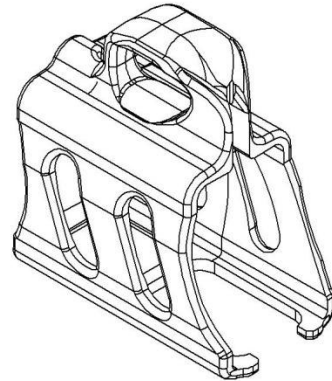

CAUTION Always route IV set tubing and AC Power Adaptor cabling to prevent patient hazard or entanglement. Identify the individual IV set lines when multiple pumps and routes of administration are practiced.

BATTERY COMPATIBILITY

Standard Battery (P/N 35702)

The standard battery is compatible with all SIGMA Spectrum pumps.

802.11b Wireless Battery Module Compatibility (P/N 35083)



The 802.1b Wireless Battery Module (P/N 35083) is only compatible with pumps that DO NOT include a 'G' preceding the serial number, as shown above.

802.11b/g Wireless Battery Module Compatibility (P/N 35162)



The 802.1b/g Wireless Battery Module (P/N 35162) is only compatible with pumps that include a 'G' preceding the serial number, as shown above. The 802.11b/g Wireless Battery Module (P/N 35162) should NOT be used with pumps that do not include a 'G' preceding the serial number.

SIGMA IV SETS

Nitroglycerin/Lipid Sets: Connect IV containers to catheters. Set Description:

Cat No. Pump Calibration
99021 Hospira

Length: 99" overall
15" PVC pumping section
DEHP free vented drip chamber (60 drops/mL)
Polyethylene lined tubing
Priming Volume: 20mL
Luer Lock



Y-Type Blood Sets: Connect Blood and Saline Bags to catheters. Set Description:

Cat No. Pump Calibration
99031 Hospira

Length: 104" overall
15" PVC pumping section
200 Micron blood filter
Lower Y injection site
Priming Volume: 42mL
Luer Lock

* NOTE: IV Sets are Latex Free

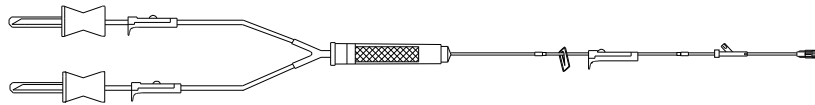

COMPATIBLE IV SETS

The following is a partial listing of the Hospira IV Sets compatible with the SIGMA Model Spectrum Pump. Please consult DOC 11181 for a full listing of compatible sets.

(SIGMA Spectrum pumps that have been calibrated for use with Hospira nominal size 0.100" I.D. Series I.V. set tubing).



or



Sets must include a Green Slide Clamp or a Yellow Keyed Slide Clamp on the section of the set to be placed into the Spectrum pump

No.	Brief Description
Primary Set Macro (15 Drops/mL)	
11309-58	LS Primary Piggyback Set, PP backcheck valve, 2 PP Y-Sites, & OL ^{2,6,7} , 106"
11540-58	LS Primary Piggyback Set, PP backcheck valve, PP Y-site & OL ² , 80"
11545-58	LS Primary Set, PP Y-site & OL, 78"
11679-65	LS Primary Piggyback Set with inline backcheck valve, 2 PP Y-sites, and OL ² , 100"
11960-68	LS Convertible Pin I.V. Set, CLAVE Y-site and OL, 100"
11961-68	LS Primary Piggyback Set with inline backcheck valve, 2 CLAVE Y-sites & OL ² , 100"
11965-68	LS Primary Piggyback Set, inline backcheck valve, 3 CLAVE Y-sites, and OL ^{2,7} , 100"
12574-48	LS Primary Set, Convertible Pin & OL, 100"
20778-48	LS Primary Set with backcheck valve, Yellow Key Slide Clamp, 2 CLAVE Y-Sites, & OL ^{2,5} , 100"
20793-48	LS Primary Set, Yellow Key Slide Clamp, with inline backcheck valve, 3 CLAVE Y-sites, 0.2 micron filter, & OL ^{2,3,5,6} , 120"
20794-48	LS Primary Set, Yellow Key Slide Clamp, with inline backcheck valve, 3 CLAVE Y-sites, & OL ^{2,5,6} , 120"
20795-48	LS Primary Set, Yellow Key Slide Clamp, with inline backcheck valve, 3 CLAVE Y-sites, & OL ^{2,5} , 120", w/Extension
20803-48	LS Primary Set, Yellow Key Slide Clamp, CLAVE Y-site & OL ⁵ , 100"
20815-48	LS Primary Set, Yellow Key Slide Clamp, with inline backcheck valve, 3 PP Y-Sites, & OL ^{2,5} , 110"
Primary Set Micro (60 Drops/mL)	
11411-78	LS Microdrip Primary Piggyback Set, w/ backcheck valve, 2 PP Y-Sites, & OL ^{1,2,6,7} , 100"
11539-78	LS Microdrip Primary Set, PP Y-site & OL ¹ , 70"
11550-78	LS Microdrip Primary Piggyback Set, PP backcheck valve, PP Y-site Set OL ^{1,2} , 80"
11962-78	LS Microdrip Piggyback Set, with inline backcheck valve, 2 CLAVE Y-sites & OL ^{1,2} , 100"
12058-78	Microdrip Set with yellow striped tubing, CAIR Clamp & OL ¹ , 112"
12426-48	LS Microdrip Piggyback Set with inline backcheck valve, 3 CLAVE Y-sites & OL ^{1,2,7} , 100"
12453-48	LS Microdrip Primary Set, 1 CLAVE Y-site & OL ¹ , 100"
20779-48	LS Microdrip Primary Set with backcheck valve, Yellow Key Slide Clamp, 2 CLAVE Y-Sites, & OL ^{1,2,5} , 100"
Primary Filter Set Micro (60 Drops/mL)	
20801-48	LS Primary Microdrip Filter Set with backcheck valve, Yellow Key Slide Clamp, 2 CLAVE Y-Sites, & OL ^{1,2,3,5} , 100"
Primary Filter Set Macro (15 Drops/mL)	
11538-68	LS Primary Piggyback Set, 0.2 micron filter, PP backcheck valve, PP Y-site & OL ^{2,3} , 80"
11963-68	LS Primary Piggyback Set, with inline backcheck valve, 2 CLAVE Y-sites, 0.2 Micron High Pressure Filter & OL ^{2,3,7} , 100"
12573-48	LS Primary Set, 0.2 micron filter, specific pumping section, 1 CLAVE Y-Site & OL ^{3,6,7} , 110"
20780-48	LS Primary Set, 0.2 micron filter with backcheck valve, Yellow Key Slide Clamp, 2 CLAVE Y-Sites, & OL ^{2,3,5} , 100"
150 mL Burette Set Macro (15 Drops/mL)	
12907-65	LS Burette Set, backcheck valve, 2 PP Y-Sites, 1 CLAVE Port, & OL ^{2,4,7,8} , 106.5"
20797-48	LS Burette Set, Yellow Key Slide Clamp, 3 CLAVE Ports, & OL ^{4,5,6} , 120"
20798-01	LS Burette Set, Yellow Key Slide Clamp, 4 CLAVE Ports, & OL ^{4,5} , 167", w/Extension
150 mL Burette Set Micro (60 Drop/mL)	
11398-20	LS Microdrip Filter SoluSet 150 x 60, PP site on burette, capped port, PP Y-Site & OL ^{1,4,7} , 100"
11964-02	LS Filter SoluSet 150 x 60, slide clamp, 1 CLAVE Y-Site & OL ^{1,4,7,8} , 77"
12341-01	LS Microdrip SoluSet 150 x 60, capped port, 1 CLAVE Y-Site & OL ^{1,4,7} , 77"
20804-01	LS Microdrip Burette Set, Yellow Key Slide Clamp, Filter Valve, Capped port, 1 CLAVE Y-Site & OL ^{1,3,4,5,7} , 110"
Primary Nitroglycerin Set Macro (15 Drops/mL)	
11993-78	Nitroglycerin Primary Pump Set (not for gravity administration), specific pumping section with slide clamp ⁶ , 110"
Fat Emulsion Set Macro (15 Drops/mL)	
12060-58	Fat Emulsion Set, non-DEHP (except pump segment with connections), slide clamp on pump segment ⁶ , 110"

Y-Type Blood Set (10 drops/mL)

- 11994-48 Y-Type Blood Set, 170 micron blood filter chamber, & OL^{3,9}, 105"
- 12450-48 LS HEMA Y-Type Blood Set, 1 CLAVE Y-Site, w/210 micron blood filter chamber, & Secure Lock^{3,9}, 100"
- 20796-48 LS Y-Type Blood Set, Yellow Key Slide Clamp, 1 CLAVE Y-Site, w/170 micron filter, & OL^{3,5,9}, 110"
- 20805-48 LS Y-Type Blood Set, Yellow Key Slide Clamp, 1 CLAVE Y-Site, w/210 micron filter, & OL^{3,5,9}, 100"
- 20806-48 LS Y-Type Blood Set, Yellow Key Slide Clamp, 1 CLAVE Y-Site, w/170 micron filter, & OL^{3,5,9}, 100"

All sets use roller clamps referenced to as CAIR® clamp. All sets (except the Blood sets) use convertible pins.

LS = LifeShield®, OL = Option-Lok®, PP= Prepierced, CAIR®, CLAVE®, Option-Lok®, LifeShield®, Microdrip® SoluSet® are all registered names / trademarks associated with Hospira (Abbott Laboratories).

Compatible Hospira IV Sets – WARNINGS

(numbers with reference to description listing)

WARNING:

1. Microdrip chambers should not be used for flow rate settings greater than 200 mL/hr. Doing so may influence flow rate accuracy and cause nuisance air or upstream occlusion alarms.
2. When using sets with backcheck valves, flow rate settings should not exceed 500 mL/hr. Doing so may influence flow rate accuracy or cause nuisance upstream air or upstream occlusion alarms. Flow rates above 300 mL/hr may cause fluid to be siphoned from the primary container during piggyback operation (see Secondary Infusion).
3. Partially occluded filters can cause nuisance upstream air, upstream occlusion or downstream alarms and influence flow rate accuracy.
4. Burettes with closed vents, or shutoff valves will cause upstream occlusions that may not be detected by the infusion pump.
5. Yellow Key Slide Clamp sets are only compatible with Spectrum Software of 4.02.06 or higher. Keyed for correct direction of flow.
6. Sets having a length that is greater than 48 inches from the exit of the pump to the patient connection end may have an increased downstream occlusion pressure, time to occlusion and bolus at occlusion release. For rates of less than 100 mL/hr, the pump should be set to the LOW downstream pressure setting.
7. Some Sets contain two or more slide clamps. Only the slide clamp on the pumping section or on the section with the main roller clamp should be used for pumping operation and clamp detection. Other slide clamps associated with the set need to be observed and controlled by the user.
8. This set is configured with a roller clamp above the set slide clamp. When loading it into the Spectrum pump ensure proper set orientation with slide clamp located above the pump.
9. Blood sets with both clamps closed above the blood filter will cause upstream occlusions conditions that may not be detected by the pump.

See the Specification Section for Downstream Occlusion times and bolus release information.

The following is a partial listing of the Baxter IV Sets compatible with the SIGMA Model Spectrum Pump. Please consult DOC 11182 for a full listing of compatible sets.
(SIGMA Spectrum pumps that have been calibrated for Baxter “S” I.V. set tubing).



All sets must include a Blue Slide Clamp on the section of the set to be placed into the Spectrum pump.

No.	Brief Description
Primary Set Macro (10 drops/mL)	
1C8109s	Solution Set, Male luer lock, 101”
1C8160s	Solution Set, Male luer lock, 69”
1C8296s	Solution Set, Male luer lock, 125”
2C6401s	Solution Set, Interlink Y-Site (1 ea) with luer lock adapter, lever lock cannula, 76”
2C6419s	Solution Set, Interlink Y-Site (1 ea) with luer lock adapter, DUO-VENT spike, 92”
2C8401s	Solution Set, Clearlink Y-Site (1 ea) with male luer lock, 76”
2C8419s	Solution Set, Clearlink Y-Site (1 ea) with male luer lock adapter, DUO-VENT spike, 92”
2C6519s	CONTINU-FLO Solution Set, Interlink Y-Site (2 ea) with luer lock adapter, backcheck valve ² , 89”
2C6537s	CONTINU-FLO Solution Set, Interlink Y-Site (3 ea) with luer lock adapter, backcheck valve ² , 110”
2C8515s	CONTINU-FLO Solution Set, Clearlink Y-Site (1 ea) with male luer lock, backcheck valve ² , 106”
2C8519s	CONTINU-FLO Solution Set, Clearlink Y-Site (2 ea) with male luer lock, backcheck valve ² , 112”
2C8537s	CONTINU-FLO Solution Set, Clearlink Y-Site (3 ea) with male luer lock, backcheck valve ² , 110”
3C0062s	CONTINU-FLO Solution Set, Interlink Y-Site (4 ea) with 4-way large bore stopcock extension set, backcheck valve ^{2,7} , 123”
Primary Set Minidrip (60 drops/mL)	
2C6402s	Solution Set, Interlink Y-Site (1 ea) with luer lock adapter, lever lock cannula ¹ , 76”
2C6424s	Solution Set, Interlink Y-Site (2 ea) with luer lock adapter ¹ , 93”
2C8402s	Solution Set, Clearlink Y-Site (1 ea) with male luer lock ¹ , 76”
2C6520s	CONTINU-FLO Solution Set, Interlink Y-Site (2 ea) with luer lock adapter, backcheck valve ^{1,2} , 89”
2C6546s	CONTINU-FLO Solution Set, Interlink Y-Site (3 ea) with luer lock adapter, backcheck valve ^{1,2,7} , 106”
2C8546s	CONTINU-FLO Solution Set, Clearlink Y-Site (3 ea) with male luer lock, backcheck valve ^{1,2,7} , 106”
Primary Filter Set Macro (10 drops/mL)	
2C6571s	CONTINU-FLO Solution Set, 0.22 micron filter, Interlink Y-Site (2 ea) with luer lock adapter, backcheck valve ^{2,3} , 105”
2C8571s	CONTINU-FLO Solution Set, 0.22 micron filter, Clearlink Y-Site (2 ea) with luer lock adapter, backcheck valve ^{2,3} , 105”
Primary Filter Set Minidrip (60 drops/mL)	
2C6572s	CONTINU-FLO Solution Set, 0.22 micron filter, Interlink Y-Site (2 ea) with luer lock adapter, backcheck valve ^{1,2,3} , 105”
Burette Minidrip (60 drops/mL)	
2C7519s	150 mL Burette, Interlink Y-Site (2 ea) with luer lock adapter, Ball Valve Drip Chamber ^{1,4,5} , 117”
2C7562s	150 mL Burette, Interlink Y-Site (3 ea) with valveless Burette ^{1,4,7} , 115”
2C7564s	150 mL Burette, Interlink Y-Site (2 ea) with drip chamber filter valve, male luer lock adapter ^{1,4,5,7} , 105”
2C8819s	150 mL Burette, Clearlink Y-Site (2 ea) with luer lock adapter, Ball Valve Drip Chamber ^{1,4,5} , 117”
Y-Type Blood Set (10 drops/mL)	
2C6750Hs	Blood / Solution Set, Interlink Y-Site (1 ea) with luer lock adapter, (170 to 260) micron filter ³ , 115”
2C8750s	Blood/Solution Set, Clearlink Y-Site (1ea) with luer lock adapter ^{3,8} 112”
Nitroglycerin Set (10 drop/mL)	
1C8043s	Vented Nitroglycerin Set with luer lock adapter, 12” PVC pumping segment ⁶ , 133”
Nitroglycerin Set (60 drop/mL)	
2C7551s	Vented Nitroglycerin Set, Interlink Y-Site (1 ea) with luer lock adapter, 12” PVC pumping segment ^{1,6} , 106”
2C8851s	Vented Nitroglycerin Set, Clearlink Y-Site (1ea) with luer lock adapter, 11” PVC pumping segment ^{1,6} , 105”

Burette, Clearlink, CONTINU-FLOW, and Interlink are all registered names / trademarks associated with Baxter International Inc.

Compatible Baxter IV Sets – WARNINGS

(numbers with reference to description listing)

WARNING:

1. Minidrip chambers should not be used for flow rate settings greater than 200 mL/hr. Doing so may influence flow rate accuracy and cause nuisance upstream air or upstream occlusion alarms.
2. When using sets with back check valves flow rate settings should not exceed 500 mL/hr. Doing so may influence flow rate accuracy or cause nuisance upstream air or upstream occlusion alarms. Flow rates above 300 mL/hr may cause fluid to be siphoned from the primary container during piggyback operation.
3. Partially occluded filters can cause nuisance upstream air, upstream occlusion or downstream alarms and influence flow rate accuracy.
4. Burettes with closed vents, or shutoff valves will cause upstream occlusions that may not be detected by the infusion pump.
5. Ball Valve operation may not be detected as an alarm condition when using the SIGMA Spectrum Pump.
6. Rigid polyethylene lined tubing, as is often used in nitroglycerine sets, may produce as much as 10 PSI downstream occlusion pressure above the lower limit of the SIGMA Spectrum pump specification.
7. Some Sets contain two or more slide clamps. Only the slide clamp on the pumping section or on the section with the main roller clamp should be used for pumping operation and clamp detection. Other slide clamps associated with the set need to be observed and controlled by the user.
8. Blood sets with both clamps closed above the blood filter will cause upstream occlusions conditions that may not be detected by the pump.

See the Specification Section for Downstream Occlusion times and bolus release information.

LIMITED WARRANTY

SIGMA warrants, to the original purchaser, the SIGMA Spectrum Infusion Pump (hereinafter "pump") to be free from defects in material and workmanship under normal use and service for one year from the date of shipment. SIGMA's obligation under this limited warranty shall be limited to repair or replacement of pumps, which upon SIGMA's examination, are found defective in material or workmanship under normal use and service within one year from the date of purchase by the original purchaser. The repair or replacement of any pump under this limited warranty shall not extend the term of this limited warranty beyond the original term as set forth in this paragraph.

All repairs qualifying under this limited warranty must be performed by SIGMA qualified and trained service personnel. In the event that any pump is found to be defective during the aforesaid warranty period, the purchaser shall notify SIGMA in writing of any claimed defect within thirty days after such claimed defect is discovered. The pump claimed to be defective must then be promptly delivered to SIGMA or its designated representative for inspection and repair or replacement, if necessary. Pumps returned to SIGMA must be properly packaged and sent to SIGMA with postage and handling prepaid. Severe pump damage may result if SIGMA shipping cartons and inserts are not used. Shipping cartons and inserts are available from SIGMA.

This limited warranty shall not apply to defective conditions or damage caused, in whole or in part, by negligence, fluid spills, dropped pumps, misuse, abuse, improper installation, improper cleaning, alteration, or damage resulting from improper shipment to SIGMA. If, after inspection, SIGMA is unable to identify a problem, SIGMA reserves the right to invoice purchaser for such inspection.

THIS LIMITED WARRANTY IS THE SOLE AND ENTIRE WARRANTY PERTAINING TO THE PUMP AND IS IN LIEU OF AND EXCLUDES ALL OTHER WARRANTIES OF ANY NATURE WHATSOEVER WHETHER EXPRESS, IMPLIED OR ARISING BY OPERATION OF LAW, TRADE, USAGE OR COURSE OF DEALING, INCLUDING, BUT NOT LIMITED TO, WARRANTIES OF MERCHANTABILITY OR FITNESS FOR ANY PARTICULAR PURPOSE. ANY AFFIRMATION OF FACT OR PROMISE MADE BY SIGMA SHALL NOT BE DEEMED TO CREATE AN EXPRESS WARRANTY THAT THE PUMP SHALL CONFORM TO THE AFFIRMATION OR PROMISE; ANY DESCRIPTION OF THE PUMP IS FOR THE SOLE PURPOSE OF IDENTIFYING IT AND SHALL NOT BE DEEMED TO CREATE AN EXPRESS WARRANTY THAT THE PUMP SHALL CONFORM TO SUCH DESCRIPTION; ANY SAMPLE OR MODEL IS FOR ILLUSTRATIVE PURPOSES ONLY AND SHALL NOT BE DEEMED TO CREATE AN EXPRESS WARRANTY THAT THE PUMP SHALL CONFORM TO THE SAMPLE OR MODEL; AND NO AFFIRMATION, PROMISE, DESCRIPTION, SAMPLE OR MODEL SHALL BE DEEMED TO BE PART OF THE PURCHASE OF THE PUMP. PURCHASER EXPRESSLY ACKNOWLEDGES THAT THIS LIMITED WARRANTY CONSTITUTES PURCHASER'S SOLE AND EXCLUSIVE REMEDY WITH RESPECT TO ANY CLAIM OF PURCHASER ARISING OR RESULTING DIRECTLY OR INDIRECTLY FROM THE USE OF THE PUMP. IN NO EVENT SHALL SIGMA BE LIABLE HEREUNDER FOR AN AMOUNT WHICH EXCEEDS THE PURCHASE PRICE OF THE PUMP, LESS A \$150 USAGE FEE FOR EACH MONTH THE PURCHASER HAS HAD POSSESSION OF THE PUMP. NO PERSON, FIRM OR CORPORATION IS AUTHORIZED TO ASSUME FOR SIGMA ANY LIABILITY IN CONNECTION WITH THE SALE OF THE PUMP.

SIGMA SPECTRUM BATTERY PACK LIMITED WARRANTY

SIGMA International warrants, to the original purchaser, the SPECTRUM Infusion Pump Battery Pack (hereinafter Battery) to be free from defects in material and workmanship under normal use and service for one year from the date of purchase. SIGMA's obligation under this limited warranty shall be replacement of Batteries, which, upon SIGMA's examination, are found defective in material or workmanship under normal use and service within one year from the date of purchase by the original purchaser. The replacement of any Battery under this limited warranty shall not extend the term of this limited warranty beyond the original term as set forth in this paragraph.

During the aforesaid warranty period, a Battery shall be capable of accepting a full charge, as indicated by a full charge icon and maintaining the specified battery capacity as outlined in section 1.5.

It is normal for battery capacity to decrease over the life of the battery. Beyond the aforesaid warranty period, batteries may exhibit a normal decrease in capacity, depending upon age and usage. If batteries exhibit decreased capacity, they may need to be replaced.

Replacement batteries, purchased separately from SIGMA, International will be subject to the aforesaid one-year warranty.

In the event that any Battery is found to be defective during the aforesaid warranty period, the purchaser shall notify SIGMA in writing of any claimed defect within thirty days after such claimed defect is discovered. The Battery claimed to be defective must then be promptly delivered to SIGMA or its designated representative for inspection and replacement, if necessary. Batteries returned to SIGMA must be properly packaged and sent to SIGMA with postage and handling prepaid.

This limited warranty shall not apply to defective conditions or damage caused, in whole or in part, by negligence, fluid spills, dropped Pumps or Batteries, misuse, abuse, improper installation, improper cleaning, alteration, or damage caused by improper shipment to SIGMA. If, after inspection, SIGMA is unable to identify a problem, SIGMA reserves the right to invoice the purchaser for such inspection.

THIS LIMITED WARRANTY IS THE SOLE AND ENTIRE WARRANTY PERTAINING TO THE PUMP AND IS IN LIEU OF AND EXCLUDES ALL OTHER WARRANTIES OF ANY NATURE WHATSOEVER WHETHER EXPRESS, IMPLIED OR ARISING BY OPERATION OF LAW, TRADE, USAGE OR COURSE OF DEALING, INCLUDING, BUT NOT LIMITED TO, WARRANTIES OF MERCHANTABILITY OR FITNESS FOR ANY PARTICULAR PURPOSE. ANY AFFIRMATION OF FACT OR PROMISE MADE BY SIGMA SHALL NOT BE DEEMED TO CREATE AN EXPRESS WARRANTY THAT THE PUMP SHALL CONFORM TO THE AFFIRMATION OR PROMISE; ANY DESCRIPTION OF THE PUMP IS FOR THE SOLE PURPOSE OF IDENTIFYING IT AND SHALL NOT BE DEEMED TO CREATE AN EXPRESS WARRANTY THAT THE PUMP SHALL CONFORM TO SUCH DESCRIPTION; ANY SAMPLE OR MODEL IS FOR ILLUSTRATIVE PURPOSES ONLY AND SHALL NOT BE DEEMED TO CREATE AN EXPRESS WARRANTY THAT THE PUMP SHALL CONFORM TO SUCH SAMPLE OR MODEL; AND NO AFFIRMATION, PROMISE, DESCRIPTION SAMPLE OR MODEL SHALL BE DEEMED TO BE PART OF THE PURCHASE OF THE PUMP. THE PURCHASER EXPRESSLY ACKNOWLEDGES THAT THIS LIMITED WARRANTY CONSTITUTES THE PURCHASERS SOLE AND EXCLUSIVE REMEDY WITH RESPECT TO ANY CLAIM OF THE PURCHASER ARISING OR RESULTING DIRECTLY OR INDIRECTLY FROM THE USE OF THE PUMP. IN NO EVENT SHALL SIGMA BE LIABLE HEREUNDER FOR AN AMOUNT THAT EXCEEDS THE PURCHASE PRICE OF THE PUMP. NO PERSON, FIRM OR CORPORATION IS AUTHORIZED TO ASSUME FOR SIGMA ANY LIABILITY IN CONNECTION WITH THE SALE OF THE PUMP.

Appendix A

APPENDIX A - SPECIFICATIONS

Drug Error Prevention

“A” pump

- Includes Drug Library
- Prevents wrong dose rate mode and dose rate

“C” pump

- Includes Drug Library
- Prevents wrong dose rate mode and dose rate
- Includes Wireless Battery Module for wireless communication

Master Drug Library (MDL)

- PC based, pharmacy edited and controlled, customized in-house list of all IV and epidural drugs, along with their safe delivery parameters
- Up to 1000 drugs and 32 care areas
- Care area enable:
 1. same name/same concentration drugs to have different dose rate limits
 2. pump configurations for maximum; rate, VTBI, patient weight and occlusion level
- Each drug entry includes the care area, drug name, concentration, dose rate mode, bolus mode, starting dose rate, soft (able to be exceeded) and hard (not able to be exceeded; an optional setting) dose rate and bolus limits, volume to be infused (VTBI), primary or secondary IV container, and pump screen color.

Drug Library Transfer

Accomplished by:

- Transfer from a wireless network connection to a pump using a wireless battery module
- Transfer from the PC to a mobile PDA and then transfer by infrared from the PDA to a pump

Infusion Modes

- Large and small volume parenterals (LVP).

Standard Gravity IV Sets

- Standard gravity IV sets from Baxter and Hospira.

Size and Weight

With Standard Battery

- Without IV pole clamp – 5.8” H x 4.2” W x 2.5” D, weight 25.5 oz ± 1.0 oz.
- With IV pole clamp – 5.8” H x 6.4” W x 4.7” D, weight 33.5 oz ± 1.0 oz.

With Wireless Battery Module

- Without IV pole clamp – 6.3” H x 4.2” W x 2.5” D, weight 26.5 oz ± 1.0 oz.
- With IV pole clamp – 6.3” H x 6.4” W x 4.7” D, weight 34.5 oz ± 1.0 oz.

AC Power Adaptor & Protector weight 9.7 oz ±0.5 oz.

Battery

Standard Battery

- Lithium Ion, 1800 mA/h, 7.4V nominal. SIGMA Part Number, 35702.
- Pump operating time on battery power is at least 8 hours at 125ml/hr with the backlight on (new battery).
- 12 hr. recharge time
- Charging occurs if AC Power Adaptor is plugged in whether pump is ON or OFF

Wireless Battery Module (802.11b)

- Lithium Ion, 1800 mA/h, 7.4V nominal. SIGMA Part Number, 35083
- Capacity 4 hrs (500 mL) at 125 mL/hr at the highest backlight settings.
- 16 hr. recharge time

- Charging occurs if AC Power Adaptor is plugged in, whether pump is ON or OFF
- Wireless Battery Module (802.11b/g)
- Lithium Ion, 1800 mA/h, 7.4V nominal. SIGMA Part Number, 35162
 - Capacity 4 hrs (500 mL) at 125 mL/hr at the highest backlight settings.
 - 16 hr. recharge time
- Charging occurs if AC Power Adaptor is plugged in, whether pump is ON or OFF

Pump Characteristics and Flow Rate Accuracy

- Linear peristaltic mechanism
- 0.5 – 999 mL/hr flow range in 0.1 mL/hr increments from 0.5 to 99.9 mL/hr and 1 mL/hr increments thereafter
- Volumetric accuracy (based on volume collected over one hour) using standard Hospira, Baxter
- $\pm 5\%$ from 2 – 800 mL/hr, >800 mL/hr $\pm 10\%$ for Hospira $\pm 5\%$ from 2 – 999 mL/hr for Baxter, 0.5 – 1.9 mL/hr ± 0.1 mL. Total volume up to 9 liters (Hospira) or 12 liters (Baxter).
- KVO – keep vein open rate of either 1 mL/hr or the actual rate, whichever is lower, at infusion complete alarm
- maximum pump pressure - 36 PSI (which can never be obtained with operational occlusion alarm limits)

Wireless Network Interface

Wireless Battery Module (802.11b), SIGMA Part Number 35083

- Standard: IEEE 802.11b
- Transmit power: 16 dBm typical

Wireless Battery Module (802.11b/g), SIGMA Part Number 35162

- Standard: IEEE 802.11b/g

***Transmit power: 12 dBm typical* Wireless Security**

- WEP (Wired Equivalent Privacy)
 - 64/128-bit encryption (RC4)
- WPA/WPA2/802.11i
 - 128-bit TKIP/CCMP(AES) encryption
 - 802.1 x EAP authentication
 - LEAP (WEP only), PEAP
 - MSCHAPv2,
 - Pre-shared key mode (PSK)

Environmental Limits

With Standard Battery

- Operating temperature: 60 to 90°F (15.6 to 32.2° C), 20 to 90% relative humidity non-condensing
- Storage temperature: -4 to 120°F (-20 to 49°C), 10 to 90% relative humidity non-condensing

With Wireless Battery Module

- Operating temperature: 60 to 80°F (15.6 to 26.7° C), 20 to 90% relative humidity non-condensing
- Storage temperature: -4 to 120°F (-20 to 49°C), 10 to 90% relative humidity non-condensing

Display

- Full color, HRTFT, 240 x 270, LED front-lit, 0.2235 mm by 0.2235 mm dot pitch

Alarms and Alerts

- Air-In-Line: dual beam ultrasonic detector alarms for large bubbles but allows smaller bubbles to pass. Detects air bubbles $> 1''$ ($\approx 125\mu\text{L}$ Hospira, $\approx 140\mu\text{L}$

Baxter), will alarm if > 1 mL* of air in 15 min., < 50µL bubbles are omitted in the summation of the 1 mL.*

*up to 1.5mL at 60°F

- Audio: speaker actuated audio alarm, low, medium and high levels selected through the configurations screen
- Battery Missing – pump does not detect battery attached
- Depleted Battery: pump stops running, alarms for 3 minutes
- Dose Rate Limit Exceeded: the pump will run with a soft dose rate exceeded after a double confirmation, it will not run with a hard dose rate exceeded, rates must be reset within hard limits
- Downstream Occlusion: automatic restart occurs after the downstream occlusion is cleared. Actuation can be set to Low, 6 ± 4 PSI, Medium, 13 ± 6 PSI or High, 19 ± 9 PSI
- Inactivity: actuates after the pump has been inactive for 2 minutes
- Infusion Complete: occurs when the VTBI reaches zero, at which time a KVO rate begins (The previous running rate or 1 mL/hr, whichever is lower)
- In Stop – Load Set
- In Stop – Open Slide Clamp
- In Stop – Push Run
- Low Battery - < 30 minutes of battery power remain
- Shut Door
- Slide Clamp Closed – Pump Stopped
- System Error
- Upstream Occlusion
- Very Low Battery - <15 minutes of battery power remain
- Due for inspection: Preventative Maintenance and/or Network Certification

Timekeeping

- Real Time Clock, battery backed, 10 year life

Logging Memory

- 24 hr memory of all set up screens except for ramp/taper modes that are maintained permanently
- Separate pump and drug library history logs, minimum of 96 hours each under extensive logging intensive operating conditions.

AC Power

- AC Power Adaptor, low profile, covers only one outlet, Medical Grade (EN60601-1-2), Input: 100V-AC-240V-AC, 50-60Hz/200mA, Output: 9V-DC/800mA, short circuit protected, cord length 3.0 m (~ 9.75 feet). Use only SIGMA part number 55079 or equivalent.
- The SIGMA Spectrum Infusion Pump is classified according to Medical Electrical Equipment standards as:
 - Class II Equipment
 - Type BF Applied Part
 - Continuous Operation

External Interfaces

- IrDA (SIR Encoding Protocol. Supports IrOBEX). Additional Asynchronous Serial Port expansion bus available at battery terminals. Software upgrades may be performed through external RS-232.

Standards

- IEC60601-1 including collateral standards; Third Party Notified Body Testing (Reference Electromagnetic Compatibility Tables)
- IrDA® Serial Infrared Physical Layer Link Specification v1.4(IrPHY), IrDA Serial Infrared Link Access Protocol v1.1 (IrLAP) and IrDA Serial Infrared Link Management Protocol v1.1 (IrLMP), IrDA Tiny TP v1.1
- Wireless – 802.11b, 802.11g

- EIA-RS-232 levels for Asynchronous Transmit/Receive only (RS232).

FLOW RATE ACCURACY

Effect of Fluid Container Height^{1,2}

The performance of the infusion pump will be influenced by the forces of gravity on the fluid being administered to the patient. When a fluid container is positioned above or below the patient's administration site, pressure forces associated with the fluid's head-height (distance measured from the center of the pumping mechanism to the top of the fluid in the source container) will cause deviations in the nominal specification for device flow rate accuracy. The nominal head-height used for the flow rate specification is 24" (61 cm).

Effect of Back Pressure¹

Positive back pressure can influence the flow rate accuracy of the infusion. Back pressure equivalent to 300 mmHg may reduce the flow rate causing a deviation in accuracy by -9%. Negative back pressure of -100 mmHg may increase flow rate causing a deviation in accuracy of 7% Hospira and 3% Baxter IV Sets.

Notes:

¹ Reference: AAMI ID26:1998, Sub-clause 50.102

² Note: Liquid container must be vented or a collapsible bag

Flow Profile

The SIGMA Spectrum Infusion pump has the following start-up flow rate accuracy curve shape associated with stability through time. These graphs represent the variation in flow rate that is recorded from the time the infusion is started to the end of a two hour period. The graph is intended to give a picture of the "general stability" with time of the infusion. The graph is commonly called a "start-up curve". The techniques and methods of test and generation of this graph are as detailed in IEC 60601-2-24, *Medical electrical equipment – Part 2-24: Particular requirements for the safety of infusion pumps and controllers*.

Start-up Graph, First Two Hours

Set Rate 25 mL/hr

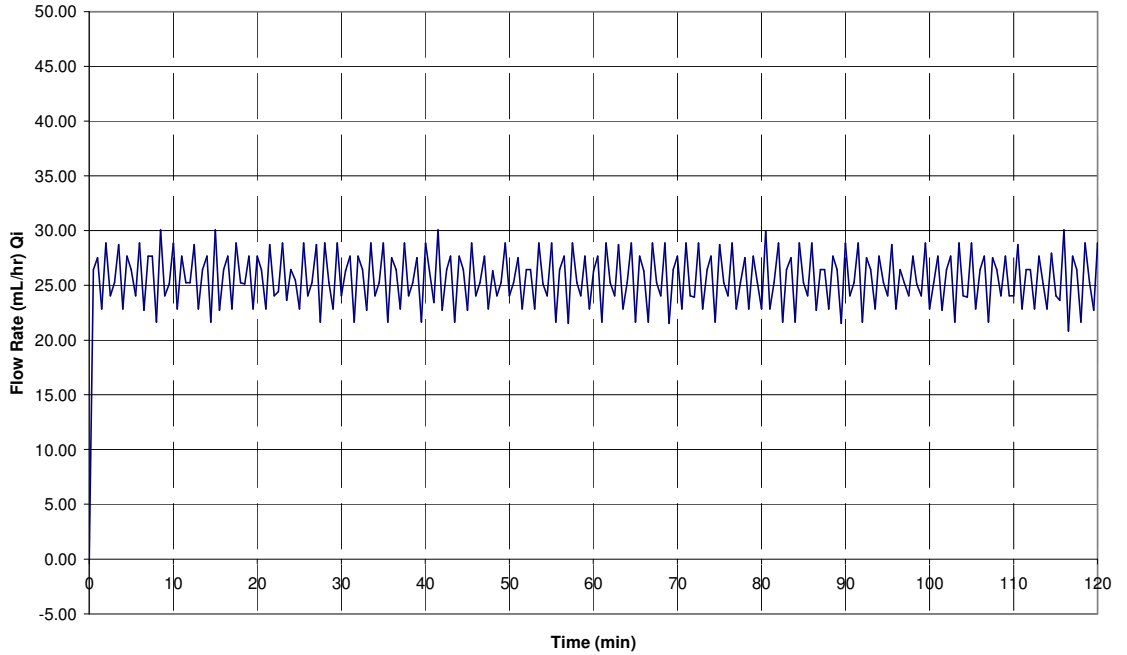

The percent variation of mean flow rate accuracy over a specific observation period may be quantified with the use of a trumpet graph. Using the rationale for development of a statistical trumpet graph as defined in IEC 60601-2-24, a presentation of the SIGMA Spectrum mean flow over a specific measurement interval is provided.

Trumpet Curve, 2nd Hour

Set Rate 25mL/Hr

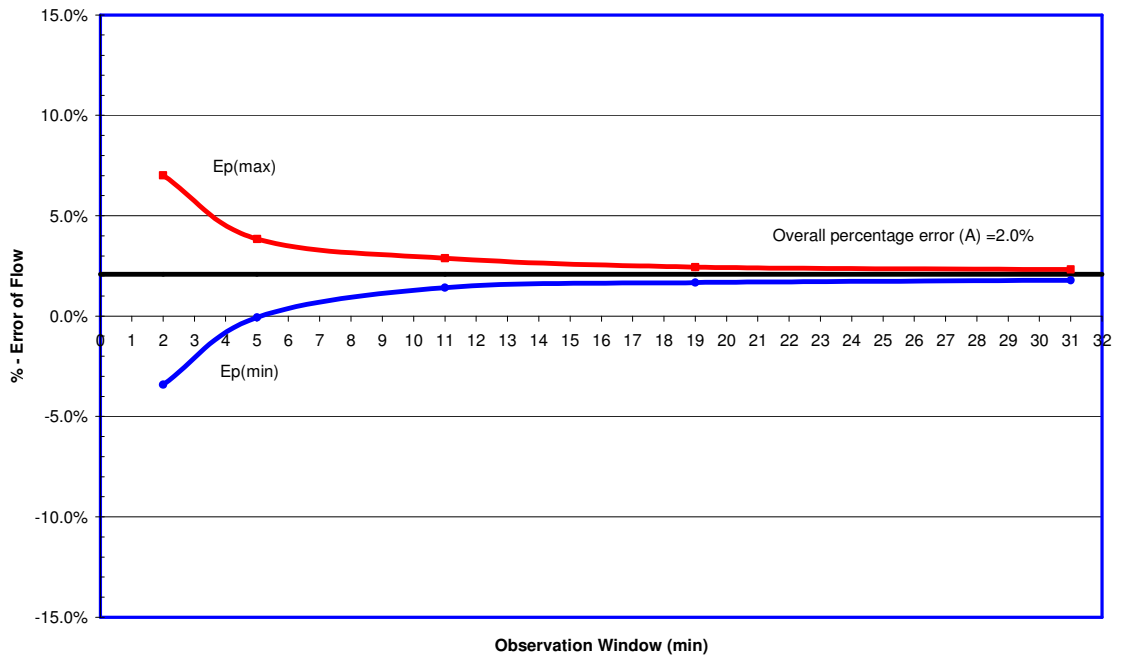

Flow rate Graph, Last Hour

Set Rate 25 mL/hr

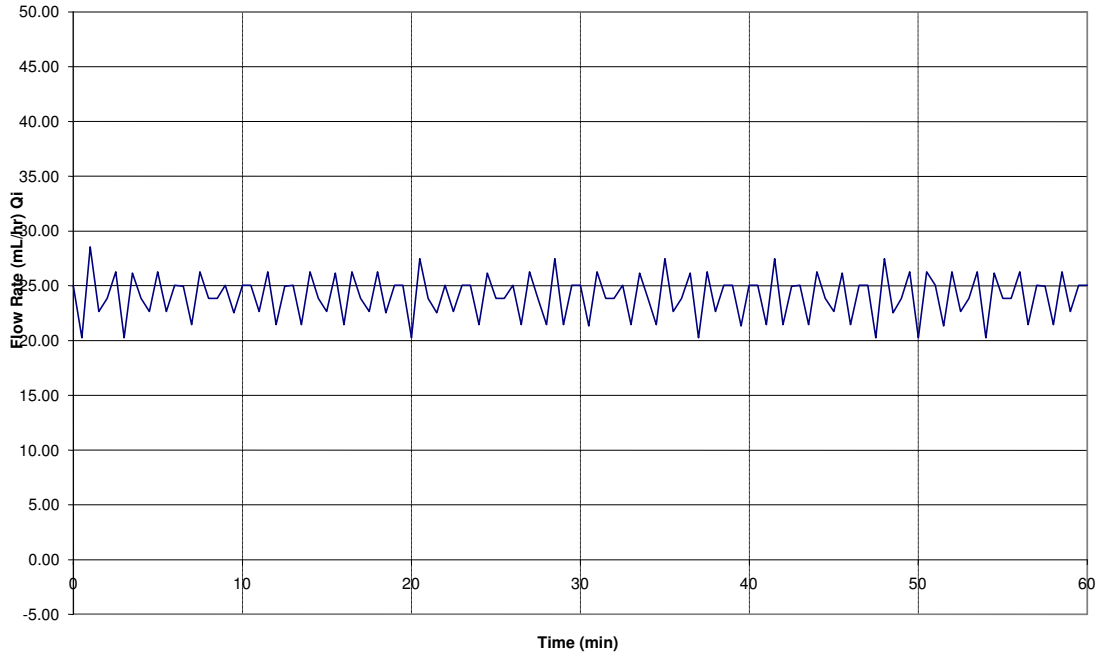

Typical of intermediate rate last* Hr Flow Accuracy

Trumpet Curve, Last Hour

Set Rate 25mL/Hr

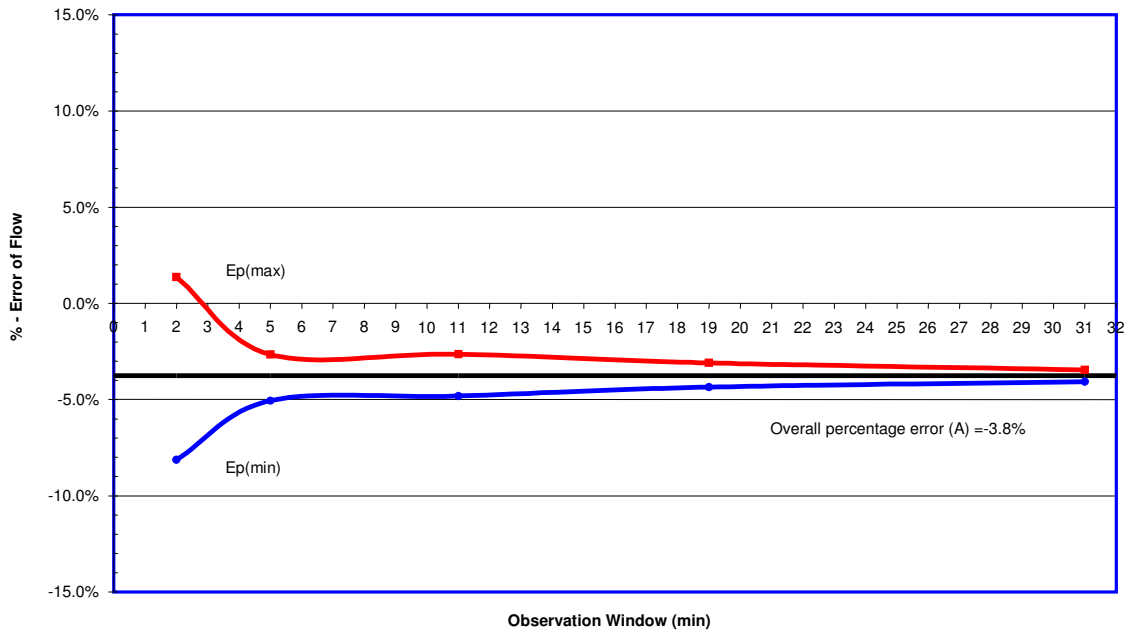

Typical of intermediate rate last* Hr, Trumpet Graph

*** Note: For Hospira calibration the last hour is the 72nd hour.
For Baxter calibration the last hour is the 96th hour.**

It is important for the clinician to understand the pharmacological influence of specific drugs based on concentrations and patient response when used in conjunction with the SIGMA Spectrum.

Pumping mechanisms produce fluctuation in fluid flow by design based on the specific mechanism type (peristaltic, piston, rotary, etc.), electronic control system and other factors related to the administration set's characteristics. Specific flow profiles are helpful in determining the correct clinical application for the infusion pump. Data is presented as requested by the applicable standards and represents the typical flow rate function of the Spectrum pump for short and long term operation. To help with the visualization of the flow inconsistencies that are typical of most infusion pumps, the start-up graphs and trumpet curves are extended to include the minimum rate (.5mL/hr) and intermediate rate (25 mL/Hr) for the SIGMA Spectrum.

NOTE: The SIGMA Spectrum is best classified as a "Volumetric Infusion Pump" as defined by the applicable standards. Reference IEC 60601-2-24 and AAMI ID26:1998, Medical electrical equipment – Part 2: Particular requirements for safety of infusion pumps and controllers.

Start-up Graph, First Two Hours
Set Rate .5mL/Hr

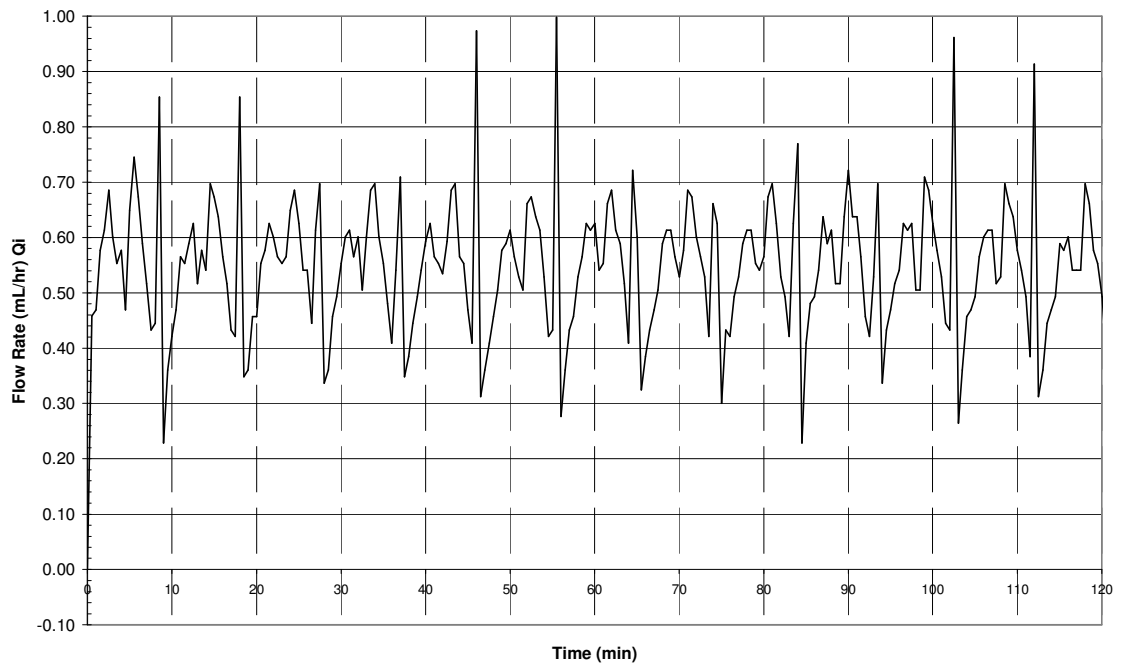

Typical of minimum rate start-up, flow rate

Trumpet Curve, 2nd Hour
Set Rate .5 mL/Hr

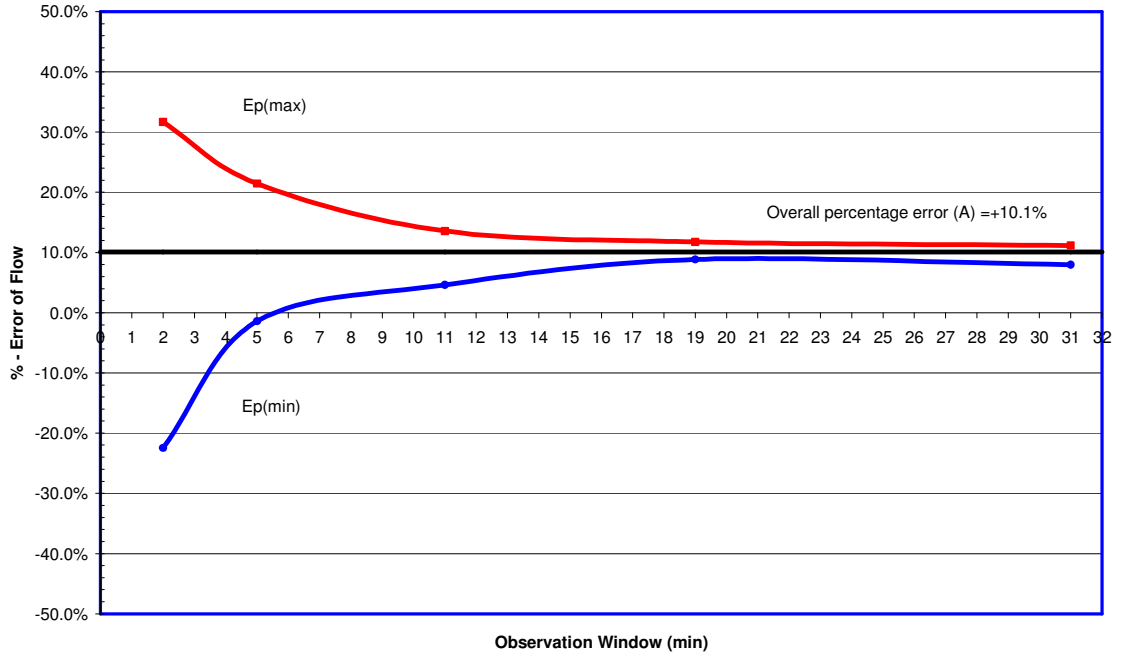

Typical of minimum rate 2nd Hr, Trumpet Graph

Flow Rate Graph, Last Hour
Set Rate .5mL/Hr

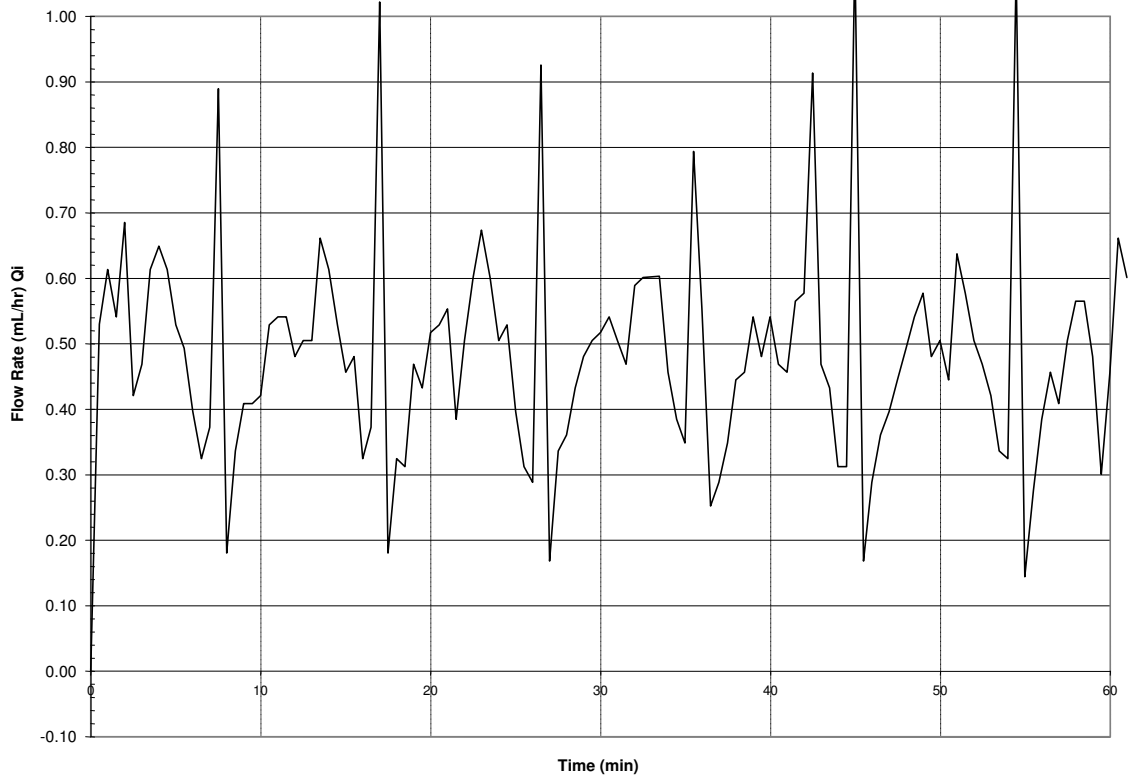

Typical of minimum rate last* Hr Flow Accuracy

Trumpet Curve, Last Hour
Set Rate .5 mL/Hr

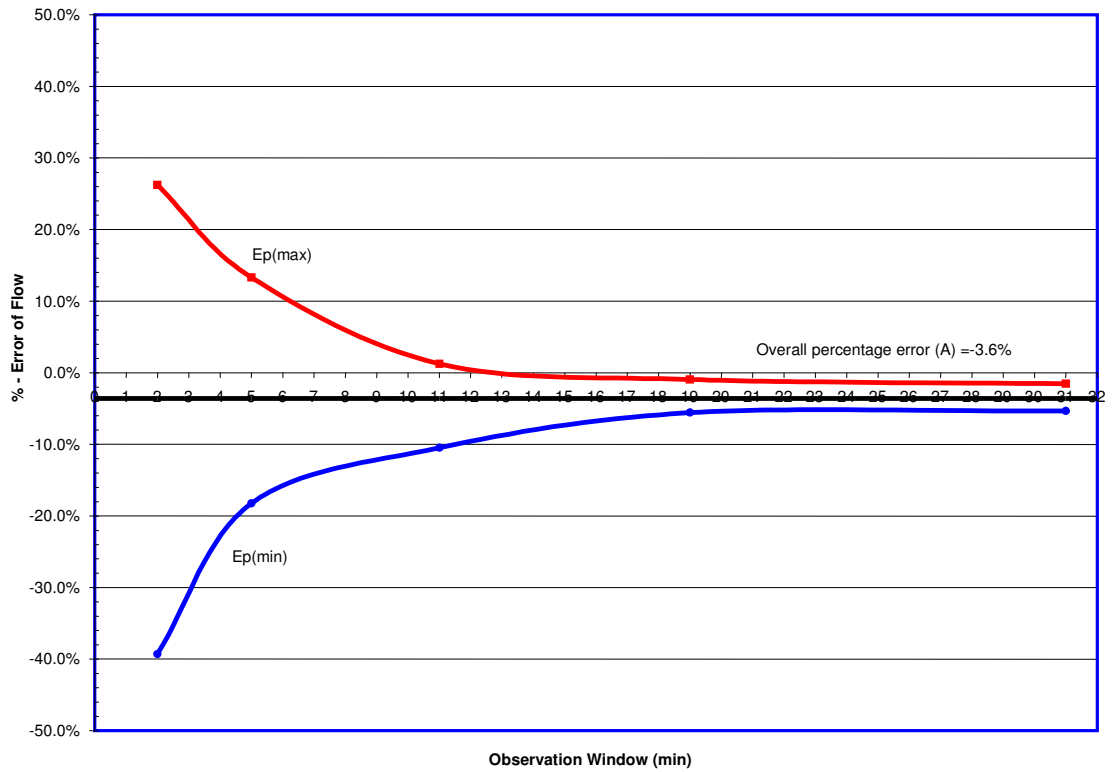

Typical of minimum rate last* Hr, Trumpet

* Note: For Hospira calibration the last hour is the 72nd hour.
For Baxter calibration the last hour is the 96th hour.

BOLUS ACCURACY

The SIGMA Spectrum IV Pump may have an optional bolus mode of operation. This feature allows the user to perform a BOLUS SETUP action. To utilize this feature the pump must be programmed with either a specific rate or a specific amount to be delivered in a certain amount of time.

If the pump is currently operating in mL/hr delivery mode, the bolus rate value is entered in mL/hr and the volume is entered in milliliter (mL). If the pump is operating in a non-mL/hr delivery mode (for example mcg/kg/min), the bolus amount would be entered in mcg/kg however the ML/HR soft key may be pressed in the setup screen to enter the bolus information in mL/hr format.

In either mode, the time is entered in minutes and seconds (min:sec). Limits are placed on the minimum and maximum amount of time for the bolus delivery. The limit constraints are contained within the software of the Spectrum pump and are necessary to control the maximum or minimum flow rate of the bolus infusion.

The accuracy of the bolus volume is dependent on the resultant flow rate that is obtained from the calculation of volume to be delivered in the time requested. For example if the maximum bolus volume is 300 mL, the maximum flow rate is obtained with a bolus time of 18:02 (min:sec) or a flow rate of approximately 999 mL/hr. Using this maximum bolus volume, and delivering the volume in the shortest amount of time, the mean value of 302 mL \pm 5% may be expected. Whereas using a minimum bolus volume (.5 mL), and delivering the volume in a reasonably shortest amount of time (1 minute), the mean value of .52 mL \pm 16% may be expected.

DOWNSTREAM OCCLUSION

Time to Occlusion

The maximum time for activation of the downstream occlusion alarm at the minimum flow rate of 0.5mL/hr is 1 hour at the minimum occlusion threshold setting. It is 3 hours at the maximum occlusion alarm threshold setting.

The maximum time for activation of the downstream occlusion alarm at the intermediate flow rate of 25mL/hr is 50 seconds at the minimum occlusion threshold setting. It is three minutes at the maximum occlusion alarm threshold setting.

Bolus Volume

The maximum bolus volume generated as a result of operation at 25 mL/hr and reaching the minimum downstream occlusion alarm threshold is 0.25mL.

The maximum bolus volume generated as a result of operation at 25 mL/hr and reaching the maximum downstream occlusion alarm threshold is 0.8mL.

Caution: Specifications for Downstream Occlusion detection times and bolus volume, after release of occlusion, are based on specific test conditions. The analytical related conditions are:

- A distance of 48" from the point of the downstream occlusion to the SIGMA Spectrum's Downstream Occlusion sensor (approximately the distance from the IV administration set's exit from the pumping channel to the point of occlusion).
- The 48" test administration set contained one "y"-site (no filters, or other components).
- Testing was at the nominal room temperature (72°F \pm 2°F).

Time to Downstream Occlusion and Bolus Volume release will generally increase under the following conditions: longer distances to the occlusion point, additional fluid volumetric area (from filters or other components within the IV set length) and hotter room temperatures.

ELECTROMAGNETIC COMPATIBILITY

Emissions

WARNING The use of accessories or cables other than those specified by SIGMA may result in increased Emissions or decreased Immunity of this medical device.

Guidance and manufacturer's declaration – electromagnetic emissions		
The SIGMA Model Spectrum Infusion pump is intended for use in the electromagnetic environment specified below. The customer or user of the Spectrum should assure that it is used in such an environment.		
Emissions test	Compliance	Electromagnetic environment - guidance
RF emissions CISPR 11	Group 1	The Spectrum uses RF energy only for its internal function. Therefore, its RF emissions are very low and are not likely to cause any interference in nearby electronic equipment.
RF emissions CISPR 11	Class B	The Spectrum is suitable for use in all establishments, including domestic establishments and those directly connected to the public low-voltage power supply network that supplies buildings used for domestic purposes.
Harmonic emissions IEC 61000-3-2	Class A	
Voltage fluctuations/ flicker emissions IEC 61000-3-3	Complies	

Immunity – ESD, transient/burst, voltage disparity, magnetic

Guidance and manufacturer's declaration – electromagnetic immunity			
The SIGMA Model Spectrum Infusion pump is intended for use in the electromagnetic environment specified below. The customer or user of the Spectrum should assure that it is used in such an environment.			
Immunity test	IEC 60601 test level	Compliance level	Electromagnetic environment - guidance
Electrostatic discharge (ESD) IEC 61000-4-2	±8 kV contact ± 15 kV air	±2 kV contact ± 15 kV air	Floors should be wood, concrete or ceramic tile. If floors are covered with synthetic material, the relative humidity should be at least 30%. See Note 1.
Electrical fast transient/burst IEC 61000-4-4	± 2 kV for power supply lines ±1 kV for input/output lines	± 2 kV for power supply lines Not applicable	Supply power quality should be that of a typical commercial or hospital environment.
Surge IEC 61000-4-5	±1 kV differential mode ±2 kV common mode	±1 kV differential mode Not applicable	Supply power quality should be that of a typical commercial or hospital environment.
Voltage dips, short interruptions and voltage variations on power supply input lines IEC 61000-4-11	<5 % 120 VAC (>95 % dip in 120 VAC) or 0.5 cycle 40 % 120 VAC (60 % dip in 120 VAC) for 5 cycles 70 % 120 VAC (30 % dip in 120 VAC) for 25 cycles <5 % 120 VAC (>95 % dip in 120 VAC) for 5 sec	<5 % 120 VAC (>95 % dip in 120 VAC) or 0.5 cycle 40 % 120 VAC (60 % dip in 120 VAC) for 5 cycles 70 % 120 VAC (30 % dip in 120 VAC) for 25 cycles <5 % 120 VAC (>95 % dip in 120 VAC) for 5 sec	Supply power quality should be that of a typical commercial or hospital environment. If the user of the Spectrum requires continued operation during power interruption, it is recommended that the Spectrum be powered from an uninterruptible power supply or the internal battery be fully charged to provide unit power as specified in this operator's manual.
Power frequency (50/60 Hz) magnetic field IEC 61000-4-8	400 A/m	400 A/m	Power frequency magnetic fields should be at levels characteristic of a typical commercial or hospital environment.

Note1: For levels 2, 3 & 4 a clearable alarm will occur with interruption of flow.

WARNING:

The Spectrum pump is not designed to be MRI-compatible nor is it intended to be used in this manner. Strong magnetic fields (those beyond the level tested) may cause the device to operate improperly.

Do not expose the SIGMA Spectrum to strong magnetic fields such as is common with MRI equipment. Doing so may cause injury to the patient and/or damage to the equipment.

Immunity – Conducted and Radiated

Guidance and manufacturer’s declaration – electromagnetic immunity			
The SIGMA Model Spectrum Infusion pump is intended for use in the electromagnetic environment specified below. The customer or user of the Spectrum should assure that it is used in such an environment.			
Immunity test	IEC 60601 test level	Compliance level	Electromagnetic environment - guidance
Conducted RF IEC 61000-4-6	3 Vrms 150 kHz to 80 MHz in ISM bands ^a	3 Vrms	Portable and mobile RF communications equipment should be used no closer to any part of the Spectrum, including cables, than the recommended separation distance calculated from the equation applicable to the frequency of the transmitter. Recommended separation distance $d = 1.2 \sqrt{P}$
Radiated RF IEC 61000-4-3	10 Vrms 150 kHz to 80 MHz in ISM bands ^a 10 V/m 80 MHz to 2.5 GHz	10 Vrms 10 V/m	$d = 1.2 \sqrt{P}$ 80 MHz to 800 MHz $d = 2.3 \sqrt{P}$ 800 MHz to 2.5 GHz Where P is the maximum output power rating of the transmitter in watts (W) according to the transmitter manufacturer and d is the recommended separation distance in meters (m). ^b Field strengths from fixed RF transmitters, as determined by an electromagnetic site survey, ^c should be less than the compliance level in each frequency range. ^d Interference may occur in the vicinity of the equipment marked with the following symbol: : “This excludes the Wireless Battery Modules, SIGMA Part Number 35083 and 35162” 
Note 1 At 80 MHz and 800 MHz, the higher frequency range applies.			
Note 2 These guidelines may not apply in all situations. Electromagnetic propagation is affected by absorption and reflection from structures, objects and people.			
^a The ISM (industrial, scientific, and medical) bands between 150 kHz and 80 MHz are 6.756 MHz to 6.795 MHz; 13.553 MHz to 13.567 MHz; 26.957 MHz to 27.283 MHz; and 40.66 MHz to 40.70 MHz.			
^b The ISM compliance level in the ISM frequency band between 150 kHz and 80 MHz and in the frequency range 80 MHz to 2.5 GHz are intended to decrease the likelihood that mobile/portable communications equipment could cause interference if it is inadvertently brought into patient areas. For this reason an additional factor of 3K is used in calculating the recommended separation distance for transmitters in these frequency ranges.			
^c Field strength from fixed transmitters, such as base stations for radio (cellular/cordless) telephones and land mobile radio, amateur radio, AM and FM radio broadcast and TV broadcast cannot be predicted theoretically with accuracy. To assess the electromagnetic environment due to fixed RF transmitters, an electromagnetic site survey should be considered. If the measured field strength in the location in which the Spectrum is used exceeds the applicable RF compliance level above, the Spectrum should be observed to verify normal operation. If abnormal performance is observed, additional measures may be necessary, such as reorienting or relocating the Spectrum.			
^d Over the frequency range 150 kHz to 80 MHz, field strength should be less than 3 V/m.			

Immunity – Separation Distances

Recommended separation distance between portable and mobile RF communications equipment and the Spectrum				
The SIGMA Model Spectrum is intended for use in an electromagnetic environment in which the RD disturbances are controlled. The customer or user of the Spectrum can help prevent electromagnetic interference by maintaining a minimum distance between the portable and mobile RF communications equipment (transmitters) and the Spectrum as recommended below, according to the maximum output power of the communications equipment.				
Rated maximum output power of transmitter W	Separation distance according to frequency of transmitter m			
	150 kHz to 80 MHz outside ISM bands	150 kHz to 80 MHz in ISM bands	80 MHz to 800 MHz	800 MHz to 2.5 GHz
	$d = 1.2\sqrt{P}$	$d = 1.2\sqrt{P}$	$d = 1.2\sqrt{P}$	$d = 2.3\sqrt{P}$
0.01	0.12	0.12	0.12	.23
0.1	0.38	0.38	0.38	.73
1	1.2	1.2	1.2	2.3
10	3.8	3.8	3.8	7.3
100	12	12	12	23

For transmitters rated at maximum output power not listed above, the recommended separation distance d in meters (m) can be determined using the equation applicable to the frequency of the transmitter, where power P is the maximum output power rating of the transmitter in watts (W) according to the transmitter manufacturer.

NOTE 1 At 80 MHz and 800 MHz, the separation distance for the higher frequency range applies.

NOTE 2 The ISM (industrial, scientific, and medical) bands between 150 kHz and 80 MHz are 6.756 MHz to 6.795 MHz; 13.553 MHz to 13.567 MHz; 26.957 MHz to 27.283 MHz; and 40.66 MHz to 40.70 MHz.

NOTE 3 An additional factor of 10/3 is used in calculating the recommended separation distance for the transmitters in the ISM frequency band between 150 kHz and 80 MHz and in the frequency range 80 MHz to 2.5 GHz to decrease the likelihood that mobile/portable communications equipment could cause interference if it is inadvertently brought into patient areas.

NOTE 4 The guidelines may not apply in all situations. Electromagnetic propagation is affected by absorption and reflection from structures, objects and people.

WARNING:

The Spectrum pump is not designed to be exposed to linear accelerator radiation nor is it intended to be used in this manner. Exposure to radiation of this type may cause the device to operate improperly.

Do not expose the SIGMA Spectrum to linear accelerator radiation. Doing so may cause injury to the patient and/or damage to the equipment.

Appendix B

Appendix B - Low / Very Low Battery Tutorial

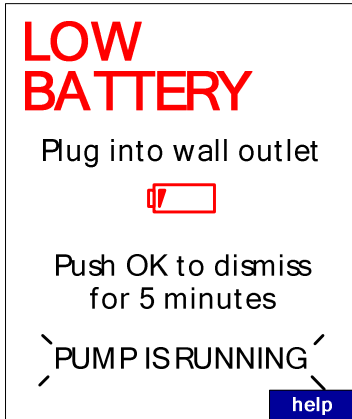

The triple-beep audio alarm shall repeat every 5 seconds.

Pressing OK shall temporarily suspend this alarm and return to RUN only when the battery level is high enough to indicate that the battery is not near the Dead Battery level (which causes the pump to stop). In this situation, the only action that can be allowed is to get the AC applied.

If connecting external power does not produce the “plug” icon (shown below), or if the alarm is not acknowledged after 2 minutes, the alarm volume shall increment up and the troubleshooting tutorial, shown on the next page, shall automatically begin.

The ‘help’ soft key may be pressed to start the tutorial immediately.

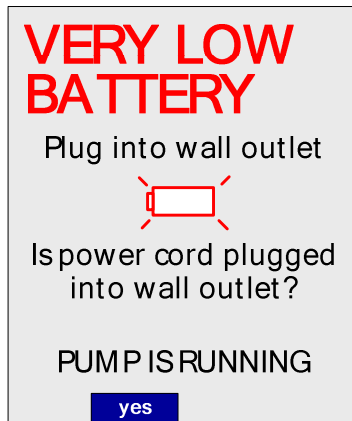

When the battery level drops very close to the Dead Battery level, the LOW message updates to VERY LOW and begins to flash in the display. The backlight also dims to the low setting to reduce battery usage and extend the operating life of the battery.

At this point, the help tutorial is also started automatically.

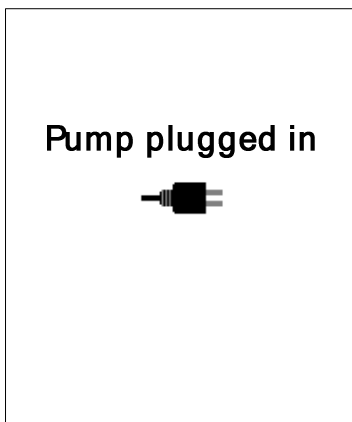

Once external power has been applied, the “plug” icon is displayed for two seconds as positive feedback before returning to normal RUN screens.

LOW BATTERY

Plug into wall outlet



Is power cord plugged into wall outlet?

exit | yes

If the Low Battery alarm is left unacknowledged for 2 minutes or if the 'help' softkey is pressed, the following troubleshooting tutorial shall begin.

The tutorial is designed to provide step-by-step confirmation that the external power supply is connected to the wall outlet, that its power light is illuminated, and that the power cord is properly connected to the Spectrum.

If external power is detected at any point during this tutorial, the "Pump plugged in" screen (shown on the previous page) shall be shown before returning to the RUN screens.

LOW BATTERY



Is wall plug light on?

exit | yes | no

LOW BATTERY



Is cord pushed firmly into back of pump?

exit | yes

LOW BATTERY

Faulty power supply



SEND PUMP FOR REPAIR

Push OK to continue

LOW BATTERY

Faulty power jack



SEND PUMP FOR REPAIR

Push OK to continue

VERY LOW BATTERY

Plug into wall outlet



Is power cord plugged into wall outlet?

exit | yes

If the Very Low Battery alarm is shown the following troubleshooting tutorial shall begin.

The tutorial is designed to provide step-by-step confirmation that the external power supply is connected to the wall outlet, that its power light is illuminated, and that the power cord is properly connected to the Spectrum.

If external power is detected at any point during this tutorial, the "Pump plugged in" screen shall be shown before returning to the RUN screens.

VERY LOW BATTERY



Is wall plug light on?

exit | yes | no

VERY LOW BATTERY



Is cord pushed firmly into back of pump?

exit | yes

VERY LOW BATTERY

Faulty power supply



SEND PUMP FOR REPAIR

Push OK to continue

VERY LOW BATTERY

Faulty power jack



SEND PUMP FOR REPAIR

Push OK to continue

Appendix C

Appendix C - Power Icons

These icons are visible in the upper left corner of the pump display.



Battery is 25% charged



Battery is 50% charged



Battery is 75% charged



Battery is 100% charged



Battery is installed and the AC adaptor is connected. Alternates between one of the battery levels above.



Battery is depleted (Red battery)

Wireless Battery Module Icons

Battery



Wireless Battery Module is being charged. Battery segments (bars) animate from left to right. (Black battery; White background)

Charging

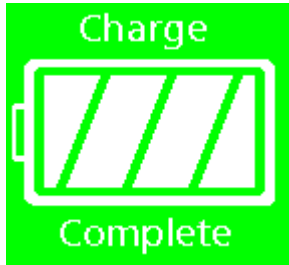

Wireless Battery Module is fully charged (White battery; Green background)



Battery Error. This will alternate with a battery code number if communication to the battery is functional. If communication to the battery is not functional the icon will be displayed without a battery code number. Refer to the Service Manual for a description of the error code. (Red battery)



AC power is supplied and battery pack is not installed. (Black battery)

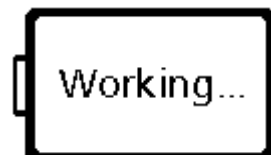

Initial pump screen when AC power is supplied and the pump is powered off. Battery charger is determining the current status of the installed battery. (Black battery)

Appendix C - Wireless icons

These icons are only visible when Wireless Battery Module is installed and in the upper right corner of the pump.



Initializing; The dot will circle the tower. Events are not sent to the network host. (Red background)



Searching for the network and host. The “?” will toggle to the left and right of the tower while searching. Events will be sent to the network upon connection to the network host. (Yellow background)



Connected to host. Signals will radiate outward. Events are sent to the network host. (Green background)



Network disabled or Wireless battery removed. Events are not sent to the network host. (Gray background)



Network module error. Events are not sent to the network host. (inverting Red and White background)



A different drug library is available to download to the pump. This icon can appear alongside any of the icon listed above. *See below on how to activate this new drug library.*

Figure 1 below shows the key lock and battery icon (upper left) and the network connection (upper right) icon.

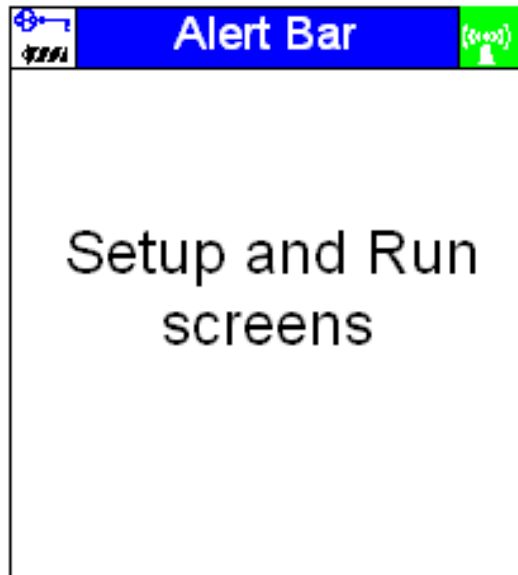



Figure 1 – Icon displays

Activating a Drug Library

The pump must be on and in the idle state (not running) for the new drug library to be loaded automatically to the pump.

The pump screen will display the status bar as the library is being installed. A confirmation screen will be displayed when the download is complete. See figure 3. Press OK.

If the pump is running

The  image may appear in the upper right corner next to one of the wireless icons indicating that a drug library is now available.

To see the new library that is available from the run screen

- Press the “options” soft key
- Arrow to select “View Information” and press OK
- Arrow to “Library Information” and press OK

The Library Information screen will display the current active drug library information and the queued (new) drug library that is ready to be activated. See figure 2

- Press the “exit” soft key to return to the run screen

Stop the pump and clear the infusion program to load the new drug library that is available

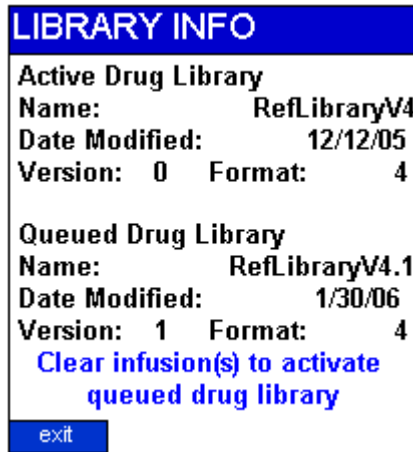

Figure 2 – Library Information

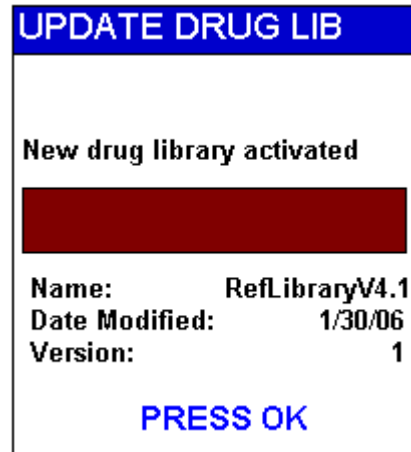

Figure 3 – Library Update

Appendix C - General Icons

The following icons are displayed on various screens in the Spectrum:



The “keypad lock” icon is shown in the upper left corner (above the power icon) of the display whenever the lock code has been entered to enable the keypad lock feature.



This icon shall be displayed next to any configuration option menu item (User or Biomed) whose setting has been assigned in the Master Drug Library to the currently selected drug. The word “**option**” will be displayed to the right of this image on any option that is an MDL-settable option and a drug has not yet been selected.